

\* به پدر و مادر خود نیکی کنید.  
قرآن کریم

# بخش ۱

## نگاره‌ها

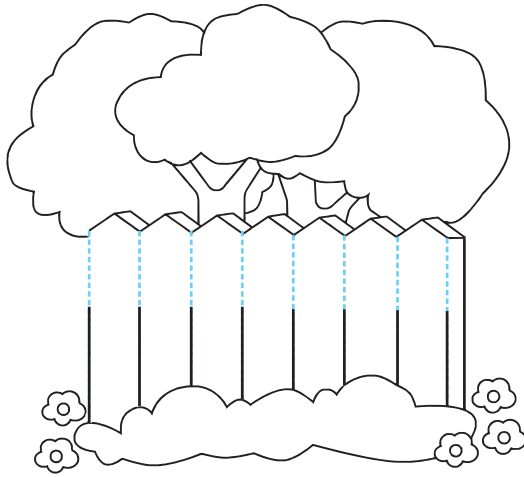

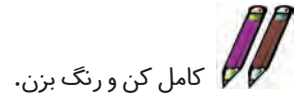
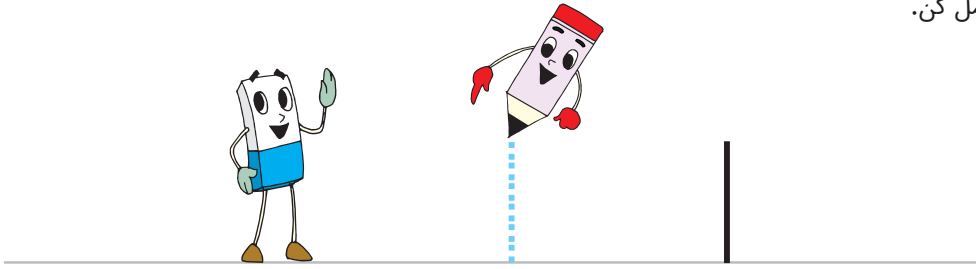

Four horizontal blue lines for writing. The top line has a series of vertical tick marks. To the right of the top line, there is a black vertical line and a red vertical line with a downward arrow. To the left of the lines, there are four empty square boxes stacked vertically.





کامل کن.

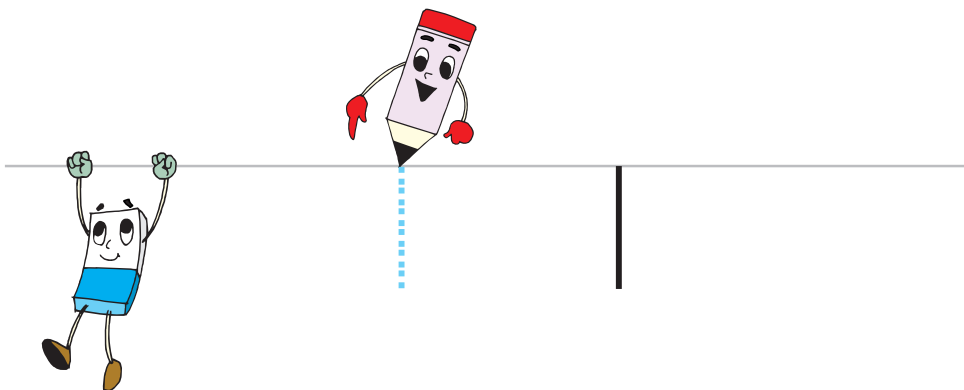

کامل کن و رنگ بزن.

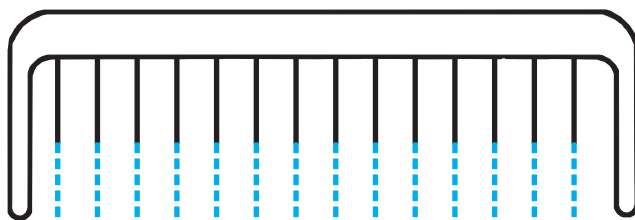

بنویس.



خدا نگه دار!

کامل کن.

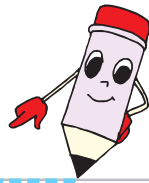
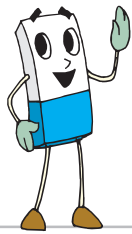

کامل کن و رنگ بزن.

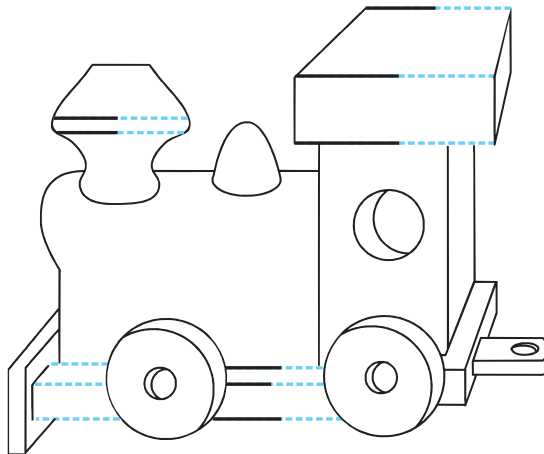

بنویس.



خسته نباشی!



کامل کن. 

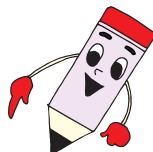
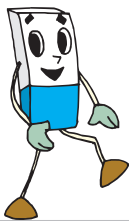

کامل کن و رنگ بزن. 

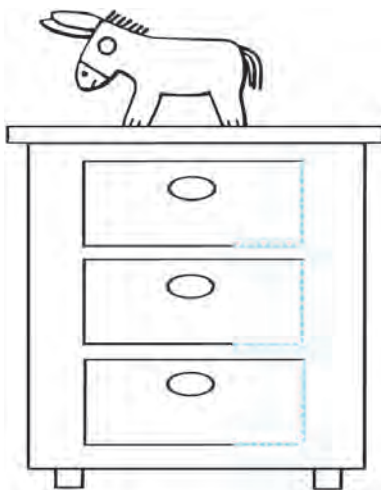

بنویس. 



به به، چه نقاشی خوبی!

سلام  
دوست من!

کامل کن.

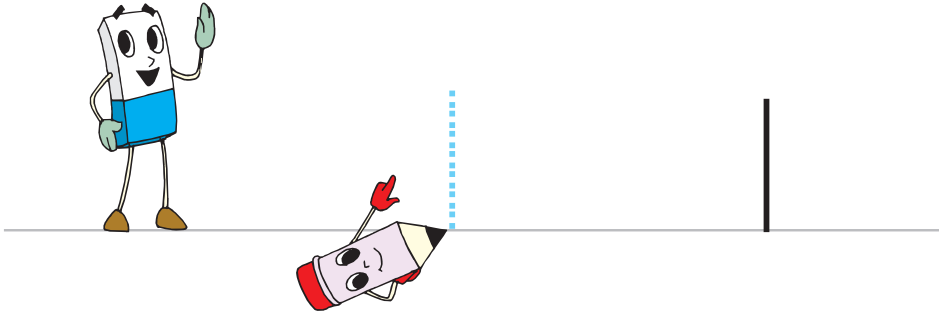

کامل کن و رنگ بزن.

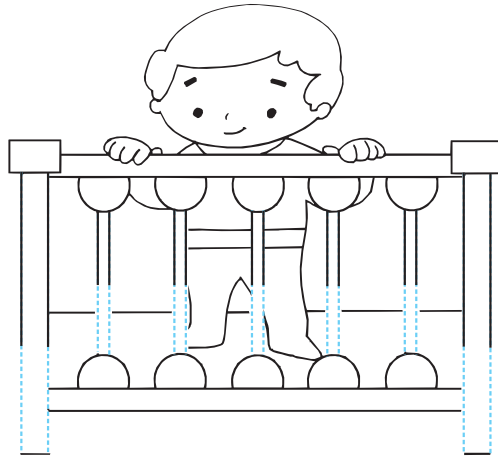

بنویس.





Handwriting practice lines consisting of a top line, a middle line, and a bottom line. There are vertical tick marks along the top line. At the end of the lines, there is a red vertical line with an upward-pointing arrow.



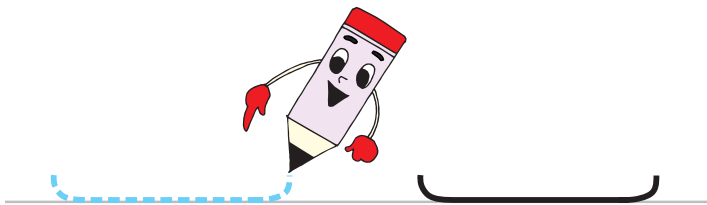

کامل کن. 



کامل کن و رنگ بزن. 

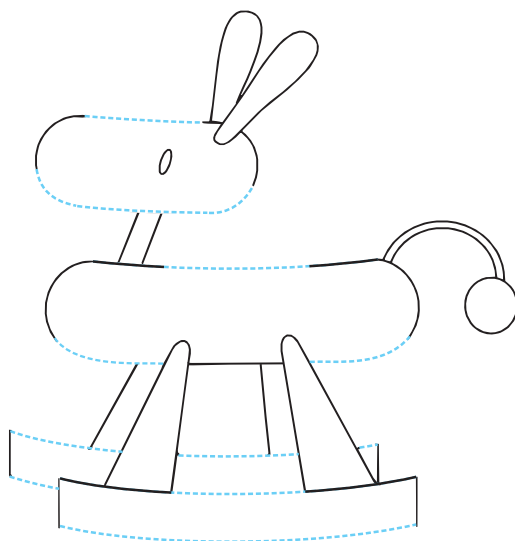

بنویس. 





کامل کن.

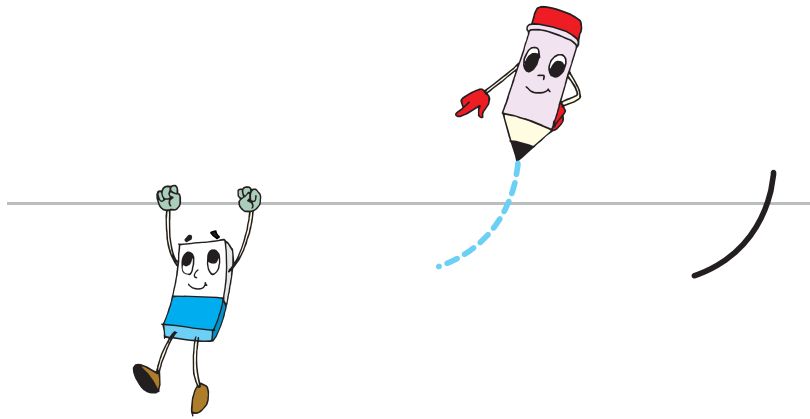

کامل کن و رنگ بزن.

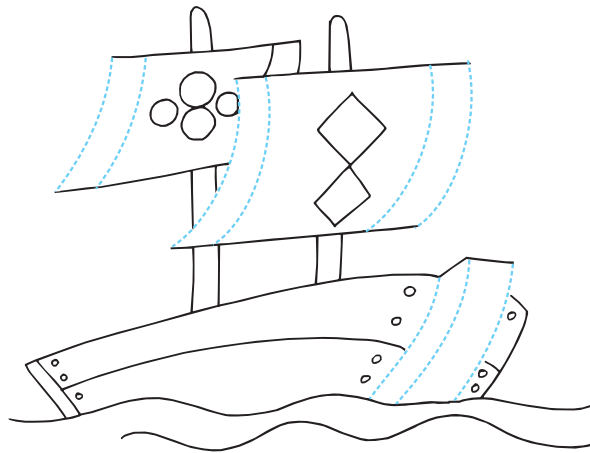

بنویس.







کامل کن. 

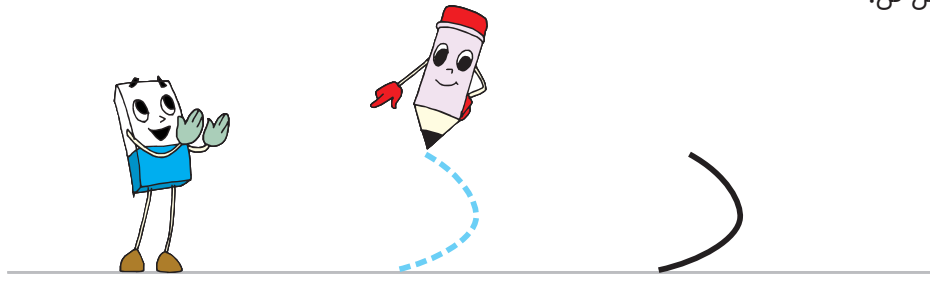

کامل کن و رنگ بزن. 

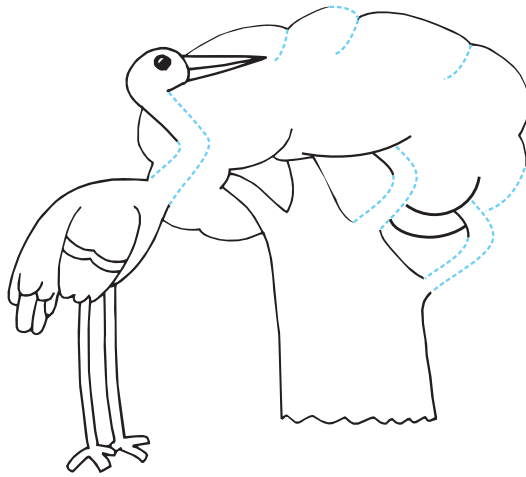

بنویس. 

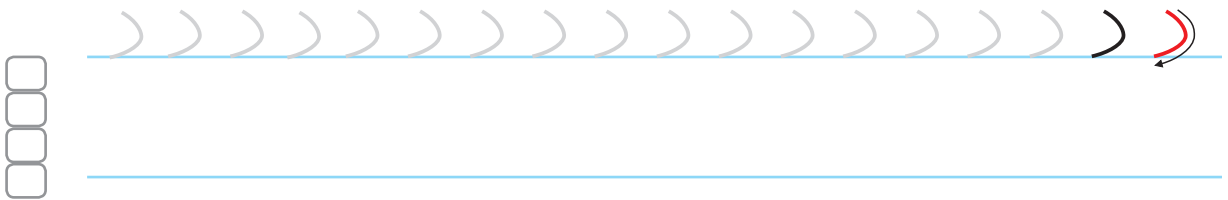

خدا قوت!



کامل کن.

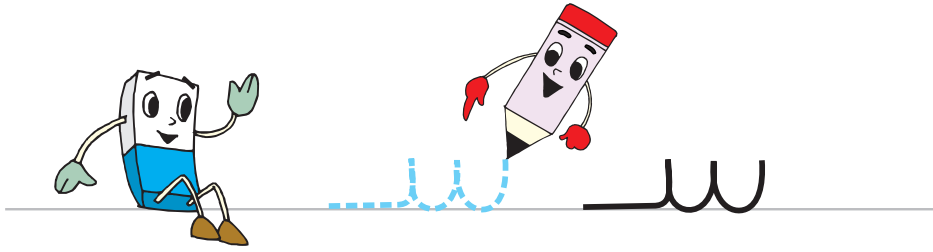

کامل کن و رنگ بزن.

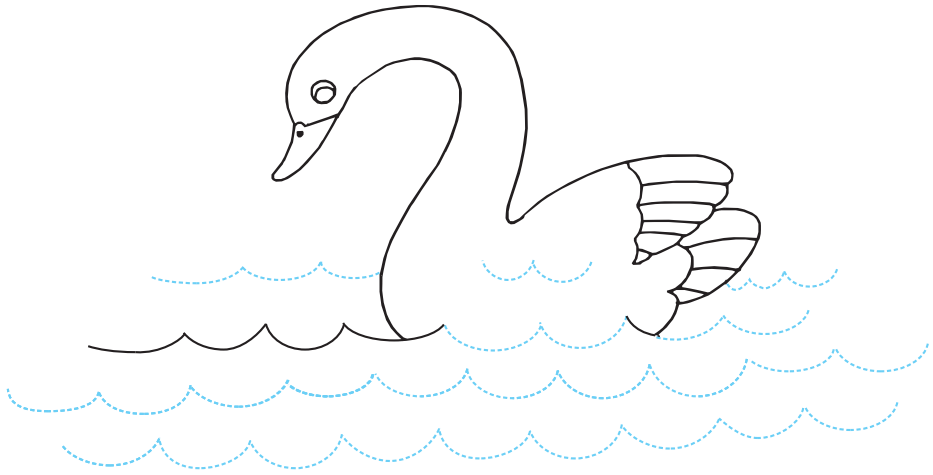

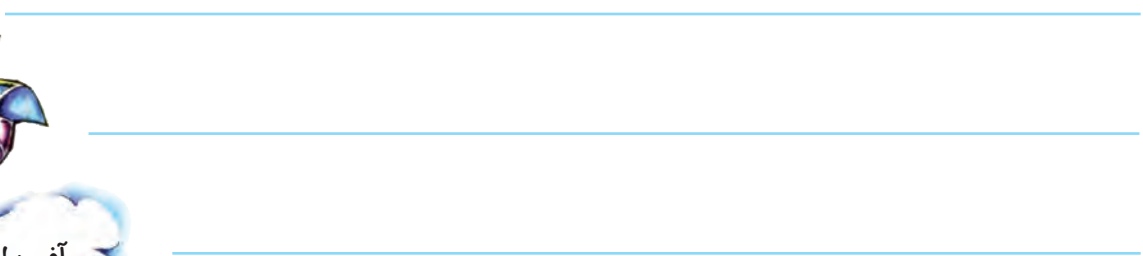

بنویس.



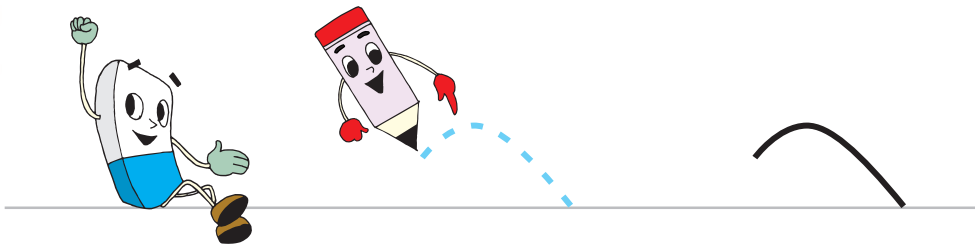

کامل کن. 



کامل کن و رنگ بزن. 

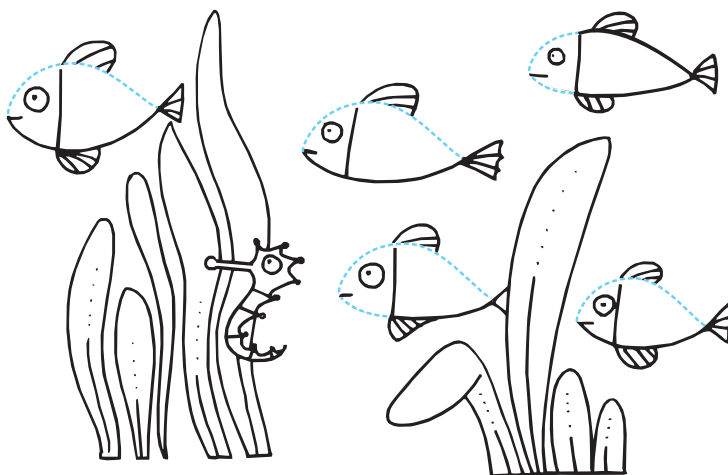

بنویس. 



سلام،  
روز به خیر!

کامل کن.

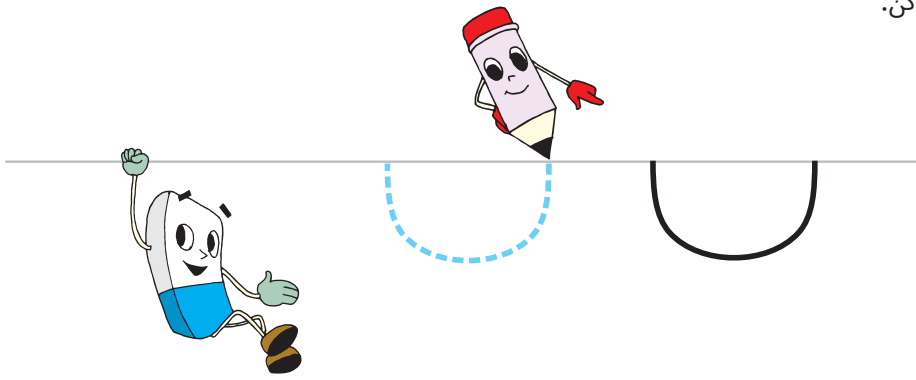

کامل کن و رنگ بزن.

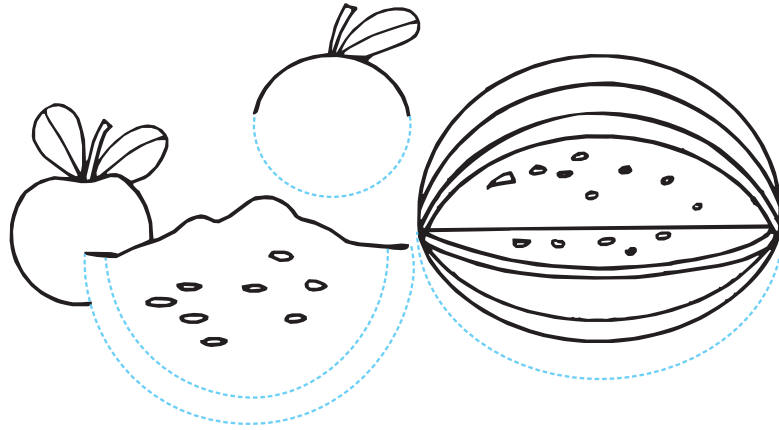

بنویس.

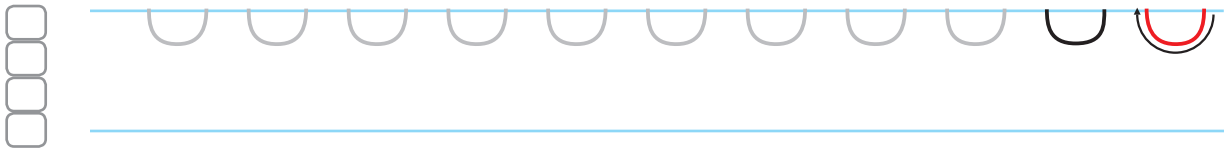

آفرین عزیزم!



کامل کن. 

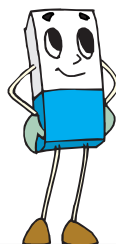

کامل کن و رنگ بزن. 

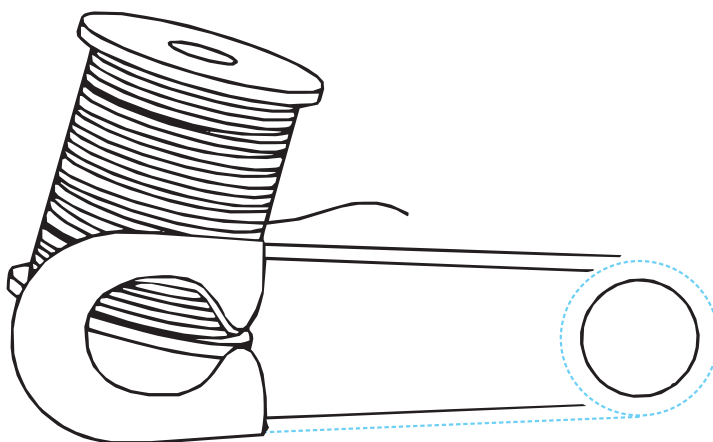

بنویس. 



روزت به خیر!

سلام  
هم شاگردی!

کامل کن.

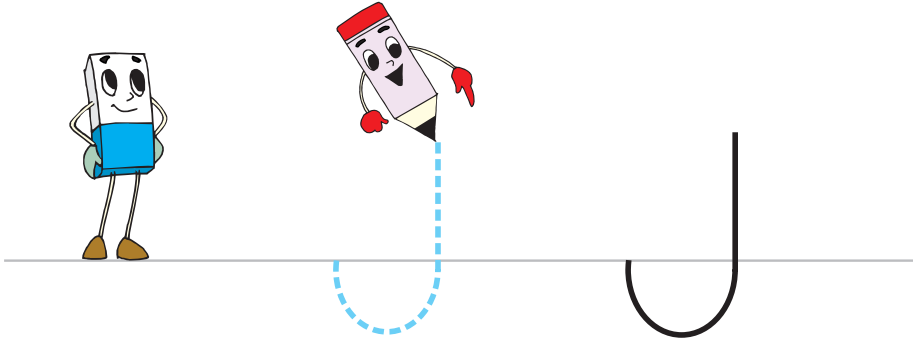

کامل کن و رنگ بزن.

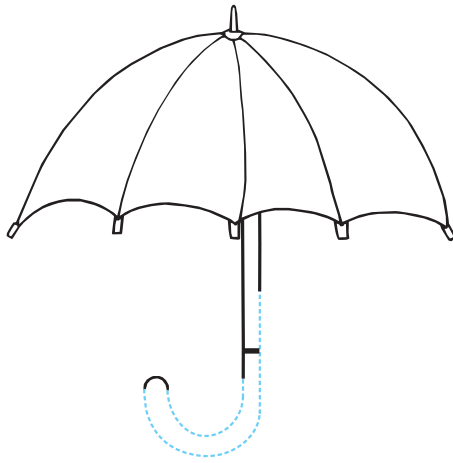

بنویس.



با هم دوست  
باشیم!



کامل کن.

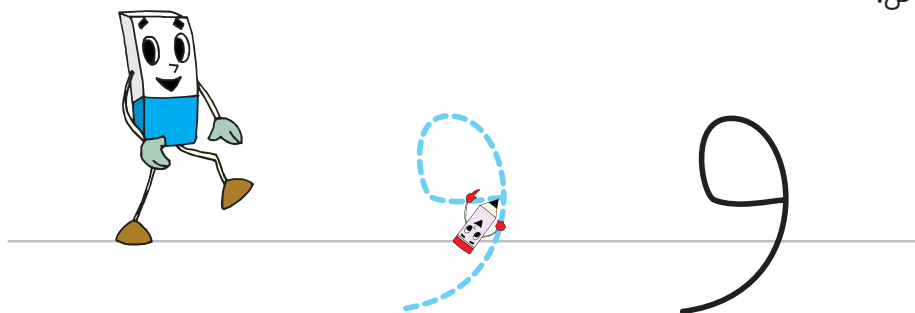

کامل کن و رنگ بزن.

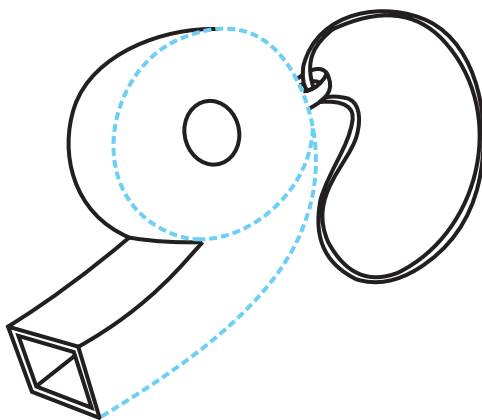

بنویس.



آفرین!

کامل کن.

دوست من  
سلام!

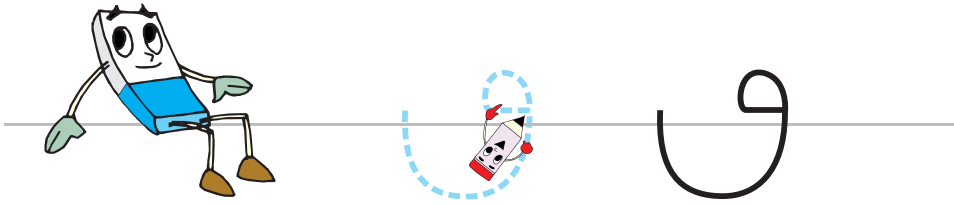

کامل کن و رنگ بزن.

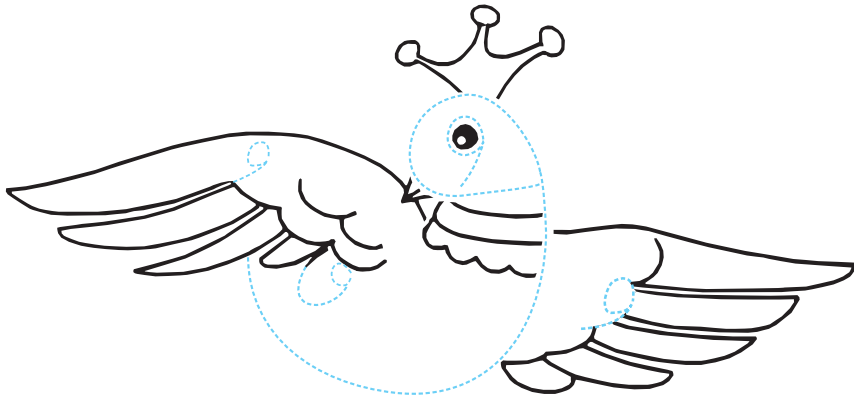

بنویس.

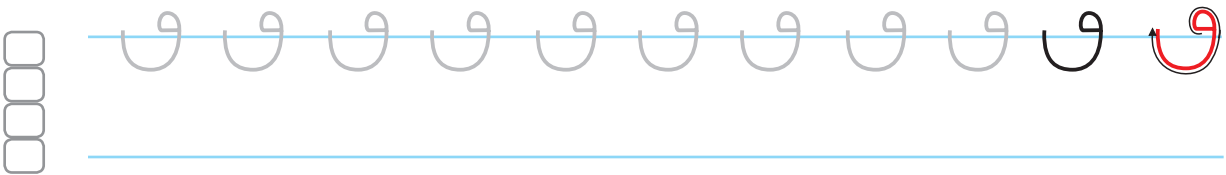

با هم مهربان  
باشیم!





کامل کن. 



کامل کن و رنگ بزن. 

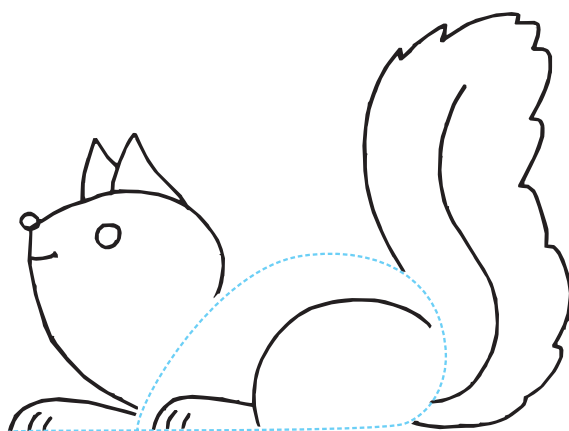

بنویس. 



خوش  
به حالت!

کامل کن.

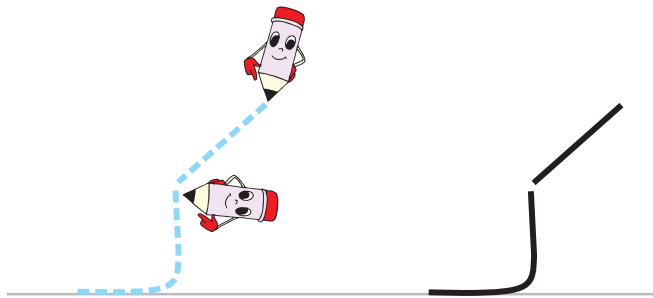

کامل کن و رنگ بزن.

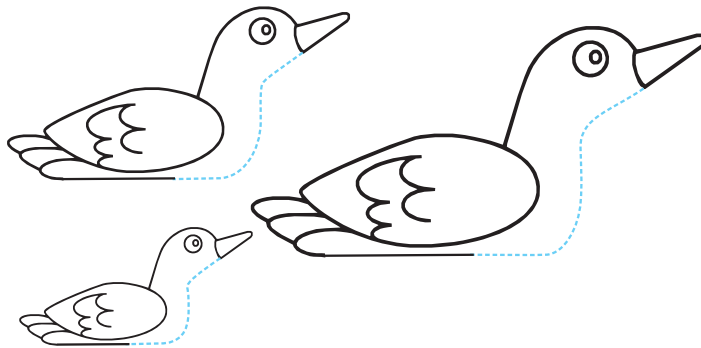

بنویس.

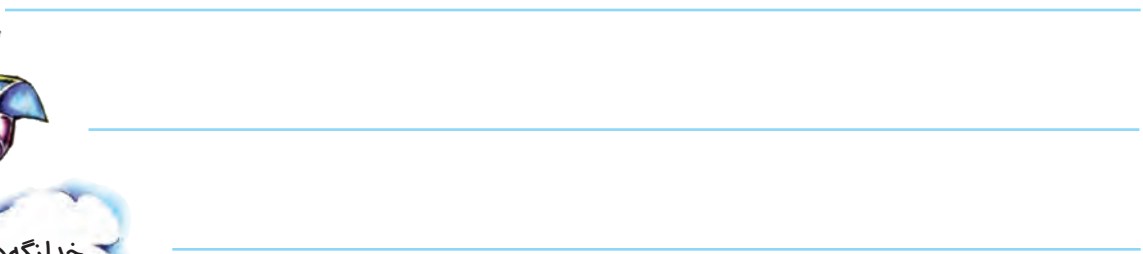



کامل کن.

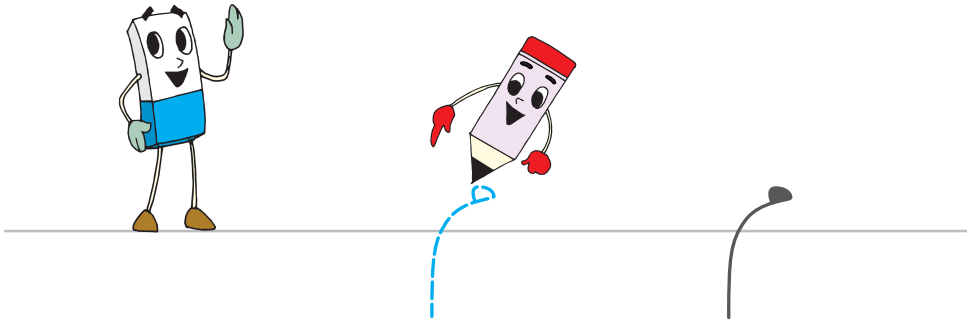

کامل کن و رنگ بزن.

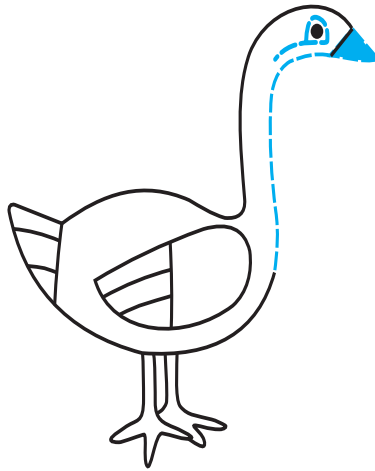

بنویس.

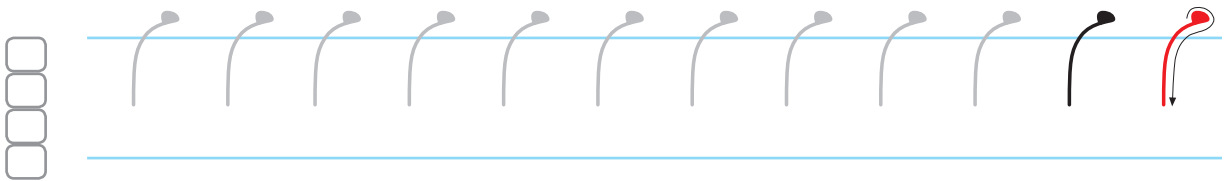

آفرین!



کامل کن.

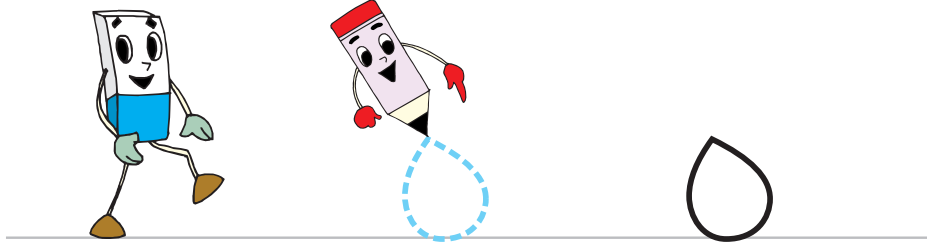

کامل کن و رنگ بزن.

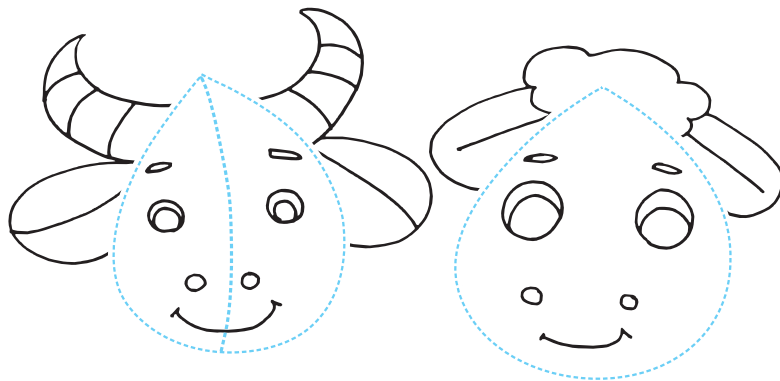

بنویس.

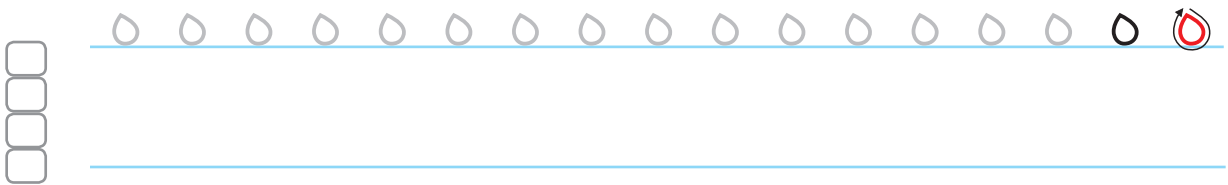

روز به خیر!



کامل کن. 

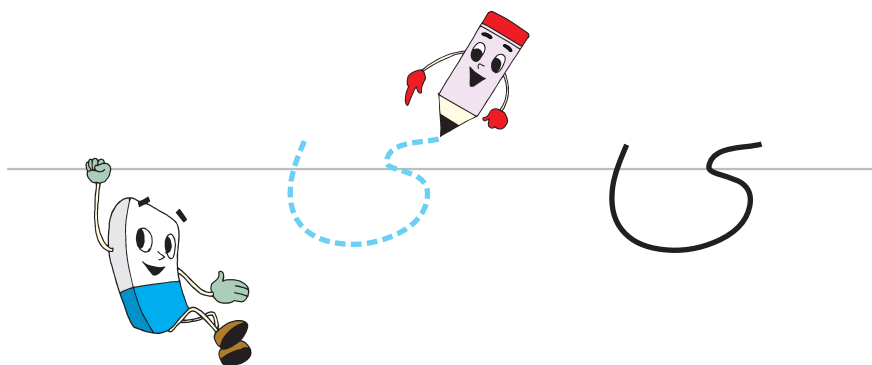

کامل کن و رنگ بزن. 

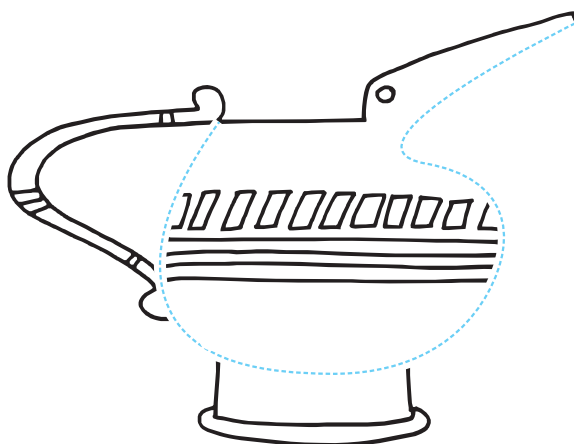

بنویس. 



ی ی ی ی ی ی ی ی ی ی ی



شادباش!

بنویس.



س س س س س س س س س س

Blank handwriting practice lines for the letter 'س'.

ح ح ح ح ح ح ح ح ح ح

Blank handwriting practice lines for the letter 'ح'.

ح ح ح ح ح ح ح ح ح ح



خیلی خوب!



بنویس.

ب ب ب ب ب ب ب ب



Blank handwriting line

Blank handwriting line

Blank handwriting line

ه ه ه ه ه ه ه ه



Blank handwriting line

Blank handwriting line

Blank handwriting line

و و و و و و و و



Blank handwriting line



Blank handwriting line

