

بِسْمِ اللّٰهِ الرَّحْمٰنِ الرَّحِیْمِ

# زبان تخصصی

رشته تربیت بدنی

گروه تحصیلی علوم ورزشی

زمینه خدمات

شاخه آموزش فنی و حرفه ای

شماره درس ۴۴۷۵

و ثوق یزدانی، محمدعلی	۴۲۸
زبان تخصصی/ مؤلفان: محمدعلی و ثوق یزدانی، محمد مشاهری فرد، محمد خبیری.	ف۶۴/
تهران: شرکت چاپ و نشر کتابهای درسی ایران، ۱۳۹۵.	ز ۴۱۶ و /
۹۰ ص. مصور. - (آموزش فنی و حرفه ای؛ شماره درس ۴۴۷۵)	۱۳۹۵
متون درسی رشته تربیت بدنی گروه تحصیلی علوم ورزشی، زمینه خدمات.	
برنامه ریزی و نظارت، بررسی و تصویب محتوا: کمیسیون برنامه ریزی و تألیف کتابهای درسی	
رشته تربیت بدنی دفتر تألیف کتابهای درسی فنی و حرفه ای و کار دانش وزارت آموزش و پرورش.	
۱. زبان انگلیسی - کتابهای درسی برای خارجیان - فارسی ۲. زبان انگلیسی - کتابهای	
قراأت - تربیت بدنی. الف. مشاهری فرد، محمد. ب. خبیری، محمد. ج. ایران. وزارت آموزش و	
پرورش. کمیسیون برنامه ریزی و تألیف کتابهای درسی رشته تربیت بدنی. د. عنوان. ه. فروست.	

همکاران محترم و دانش‌آموزان عزیز :

پیشنهادات و نظرات خود را درباره محتوای این کتاب به نشانی  
تهران - صندوق پستی شماره ۴۸۷۴/۱۵ دفتر تألیف کتابهای درسی  
فنی و حرفه‌ای و کاردانش، ارسال فرمایند.

info@tvoccd.sch.ir

پیام‌نگار (ایمیل)

www.tvoccd.sch.ir

وب‌گاه (وب‌سایت)

وزارت آموزش و پرورش

سازمان پژوهش و برنامه‌ریزی آموزشی

برنامه‌ریزی محتوا و نظارت بر تألیف : دفتر تألیف کتابهای درسی فنی و حرفه‌ای و کاردانش

نام کتاب : زبان تخصصی - ۴۹۸/۴

مؤلفان : محمدعلی و ثوق یزدانی، محمد مشاهری فرد و محمد خبیری

اعضای کمیسیون تخصصی : حسین کرم‌نژاد، فریبا حسین‌آبادی، محمد خبیری، معصومه سلطان‌رضوانفر،

علی شاه‌محمدی و حمیده نظری تاج‌آبادی

آماده‌سازی و نظارت بر چاپ و توزیع : اداره کل نظارت بر نشر و توزیع مواد آموزشی

تهران : خیابان ایرانشهر شمالی - ساختمان شماره ۴ آموزش و پرورش (شهید موسوی)

تلفن : ۹-۸۸۸۳۱۱۶۱، دورنگار : ۰۹۲۶۶-۸۸۳، کدپستی : ۱۵۸۴۷۴۷۳۵۹،

وب‌سایت : www.chap.sch.ir

رسام : حمیدرضا عرب

صفحه‌آرا : خدیجه محمدی

طراح جلد : طاهره حسن‌زاده

ناشر : شرکت چاپ و نشر کتابهای درسی ایران - تهران - کیلومتر ۱۷ جاده مخصوص کرج - خیابان ۶۱ (داروپخش)

تلفن : ۵-۴۴۹۸۵۱۶۱، دورنگار : ۰۴۴۹۸۵۱۶، صندوق پستی : ۱۳۹-۳۷۵۱۵

چاپخانه : شرکت چاپ و نشر کتابهای درسی ایران «سهامی خاص»

سال انتشار و نوبت چاپ : چاپ سیزدهم ۱۳۹۵

حق چاپ محفوظ است.

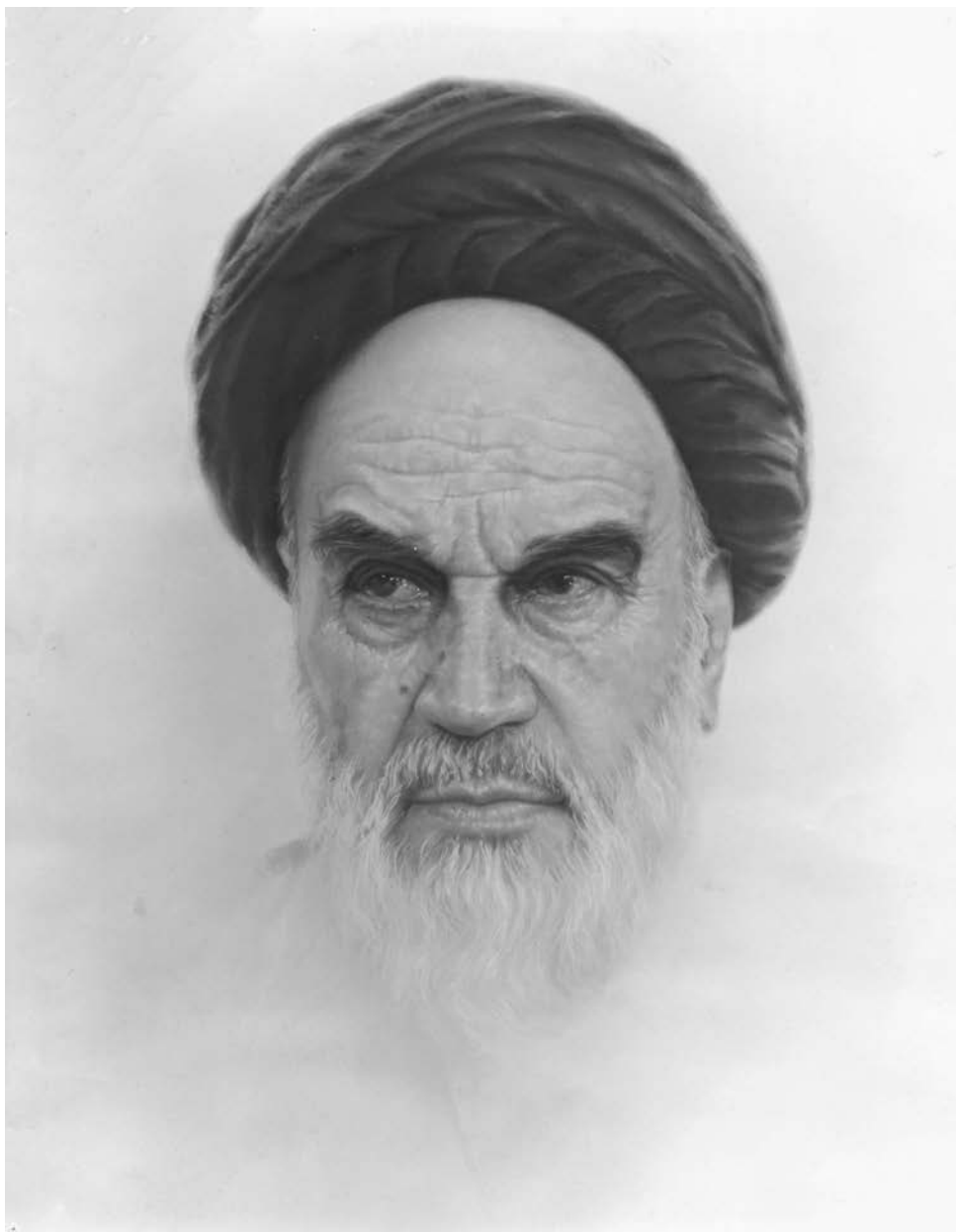

ورزش همان طور که بدن را تربیت می کند و سالم می کند عقل را هم سالم می کند.  
امام خمینی «ره»

## فهرست مطالب

LESSON ONE - PHYSICAL FITNESS	2
LESSON TWO - TRACK AND FIELD (1)	13
LESSON THREE - TRACK AND FIELD (2)	21
LESSON FOUR - SWIMMING STROKES	30
LESSON FIVE - TABLE TENNIS	39
LESSON SIX - SOCCER (FOOTBALL)	45
LESSON SEVEN - VOLLEYBALL	55
LESSON EIGHT - BASKETBALL	61
LESSON NINE - THE OLYMPIC GAMES	68
LESSON TEN - PHYSICAL EDUCATION	76
Appendix I- List of Abbreviations	84
Appendix II - List of New Words	84

## مقدمه

در میان رشته‌های تحصیلی رشته تربیت بدنی بیش از سایر رشته‌ها نیازمند ارتباط بین‌المللی است و ورزشکاران بیش از سایرین نیازمند برقراری ارتباط با مردم کشورهای مختلف دنیا هستند. هر ورزشکار در طول فعالیت‌های ورزشی خود با ورزشکاران، مربیان، داوران و سایر دست‌اندرکاران ورزشی که به زبانی غیر از زبان مادری او سخن می‌گویند مواجه می‌شود و برای ارتباط مؤثر و مفید با آنان لازم است زبان انگلیسی را در حد لازم درک کند و بتواند منظور خود را به این زبان بیان نماید. علاوه بر آن استفاده از منابع انگلیسی نیز برای فارغ‌التحصیلان این رشته امری ضروری است. درس زبان تخصصی تربیت بدنی برای پاسخگویی به همین نیاز برنامه‌ریزی شده است. با اینکه کتاب حاضر در ادامه زبان انگلیسی (۱) و (۲) تألیف شده است، دارای اهداف متفاوتی می‌باشد. در این کتاب تأکید بر درک متون و آشنایی دانش‌آموزان با اصطلاحات تربیت بدنی است و تمرینهایی که در مورد دستور زبان گنجانده شده است با هدف درک بهتر متون می‌باشد.

معرفی همه واژه‌ها و اصطلاحات ممکن بود کتاب را تبدیل به فرهنگ واژه‌های انگلیسی کند، بنابراین اصطلاحات و واژه‌های جدید تا آنجا که در گنجایش یک کتاب درسی است، معرفی شد. از هنرآموزان گرامی درخواست می‌شود دانش‌آموزان را به استفاده از فرهنگ لغت تشویق نمایند. در برخی از درس‌ها بخشی تحت عنوان Free Activity یا Free Reading وجود دارد. این بخش‌ها جزء برنامه رسمی آموزشی نیست اما مطالعه و انجام آنها به تقویت یادگیری مطالب کتاب کمک می‌کند.

هر چند تلاش شده لغزش‌های کتاب به حداقل برسد وجود اشکالاتی در کتاب اجتناب‌ناپذیر است، لذا از صاحب‌نظران، مربیان و هنرآموزان گرامی درخواست می‌کنیم نظرها و پیشنهادهای خود را از مؤلفان دریغ ندارند و ما را از طریق دفتر تألیف کتاب‌های درسی فنی و حرفه‌ای و کار دانش در رفع نواقص کتاب یاری کنند.

مؤلفان

## هدف کلی

آشنایی مقدماتی با متون و واژه‌های رشته‌های مختلف ورزشی و کاربرد آنها

# LESSON ONE



# LESSON ONE

## PHYSICAL FITNESS

### New Words:

**fit:** in shape; healthy and strong.

(I keep fit by going swimming every morning.)

**healthy:** well; not ill; how well your body is.

(You can keep healthy by eating well and exercising regularly.)

**depressed:** very sad; without hope.

(He felt very depressed about the future.)

**burn up:** use energy by doing exercises.

(Which burns up more calories, swimming or cycling ? )

**nervous:** worried or afraid.

(I felt very nervous before the examination.)

**tension:** being worried because you are waiting for something.

(Tension can give you headaches.)

**improve:** make or become better.

(Your English has improved a lot this year.)

### (I)



Thin

Many people eat too much and exercise too little. They feel tired and heavy. They look older than they really are and often feel depressed. Many other people are thin and nervous. They eat the wrong kinds of food and they burn up a lot of energy because of nervous tension. They, too, often feel tired and depressed. What is the solution for such people ? How can they improve their bodies?



How can they become healthy ? Read on and find out!

## UNDERSTANDING

**PART A:** Which of the following sentences are true and which are false ? Write “T” or “F” before the sentence !

- \_\_\_\_\_ 1. All the thin and nervous people look older than they really are.
- \_\_\_\_\_ 2. Eat too much and exercise little!
- \_\_\_\_\_ 3. Nervous and depressed people are not usually healthy.

**PART B:** Write complete answers to the following questions !

1. What does “they” in line 6 refer to ?
2. What makes some people burn up a lot of energy ?
3. Who often feels tired and depressed ?

**PART C:** Choose the best answer !

1. According to the passage, if you eat too much, you may feel \_\_\_\_\_  
a. thin and nervous                      b. tired and heavy  
c. improve your body                      d. find the solution
2. Nervous people \_\_\_\_\_ their energy through tension.  
a. improve                                      b. borrow  
c. burn-up                                        d. gain
3. If you eat the right kinds of food, you \_\_\_\_\_  
a. will stay healthy                              b. feel depressed and tired  
c. should exercise to stay strong and healthy  
d. will never need to exercise to stay strong and healthy
4. The word “heavy” in line 2 is \_\_\_\_\_  
a. an unhealthy sign                              b. essential to good health  
c. a healthy sign                                      d. a solution for such people

## **PART D: Imperatives**

Read these sentences .Put a check mark (✓) in front of the correct imperatives.

1. Amir is hungry.  
Tell Amir what to do!  
 Eat some food!  
 Drink some water!
2. Your friend eats the wrong kind of food.  
Tell your friend what to do !  
 Improve your body!  
 Eat the right kind of food!
3. Ali feels tired and depressed.  
Tell him what to do.  
 Do some exercises!  
 Eat too much!
4. My uncle is depressed and nervous .  
Tell me what to do for him!  
 Leave him alone.  
 Read and find out!

## **New Words:**

**tighten:** cause something to become tight or firm.

**co-ordinate:** cause(different parts,limbs,etc.) to function together efficiently.

**posture:** way in which a person holds himself as he stands, walks or sits.

**abdomen:**part of the body below the chest and diaphragm,containing stomach,bowels and digestive organs.

**vital:** very important; something that you must do or have.

(It is vital to warm yourself up before doing heavy exercises.)

**soccer:** football.

(In the United States, football is known as soccer.)

**circulate:** move in a closed path.

(Blood circulates in the body as water does in the heating system of a house.)

**relaxing :** helping you to rest or become less anxious.

(After a hard day at work, you need a relaxing evening.)

**breathe :** take in and let out air through your nose and mouth.

(The coach told me to breathe in and then breathe out again slowly.)

## II

Exercise is vital to good health . A walk around the block or to the corner for a newspaper is not much exercise. Swimming, tennis, basketball and soccer are good examples of sports which use all the muscles in the body. The muscles are tightened; the heart beats faster and circulates the blood through the body; breathing and co-ordination improve. Furthermore, these sports are enjoyable and relaxing.

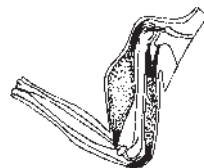

a muscle

## UNDERSTANDING

**PART A:** Which of the following sentences are false and which are true? Write “T” or “F” before the sentence !

- \_\_\_\_\_ 1. A good sport is one which involves almost all the muscles in the body.
- \_\_\_\_\_ 2. A walk round the block is enough exercise.
- \_\_\_\_\_ 3. Sports are only for enjoyment and relaxation.

**PART B:** Write complete answers to the following questions !

1. Which sports are relaxing and enjoyable?
2. What is vital to good health ?



### III

For many people , a gymnasium is an excellent place to lose weight, improve posture and tighten muscles. Both men and women can improve their bodies in a gym. Sit-ups, push-ups and other stretching and pulling exercises strengthen the neck, the shoulders, the back, the arms and the abdomen. Men lift weights of from five to two hundred pounds to build up their shoulders, arms and chest. They also work on horizontal and parallel bars and stationary bicycles. Some men squeeze hard rubber balls to strengthen their fingers and wrists.

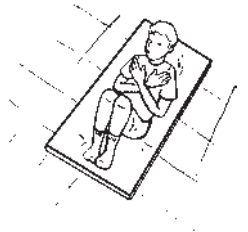

sit ups

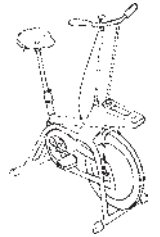

stationary bicycle

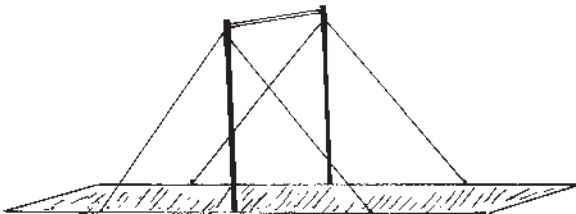

horizontal bar



push - ups

## UNDERSTANDING

**PART A:** Write “ T” or “F” before the sentence !

- \_\_\_\_\_ 1. Stretching not pulling exercises strengthen the neck, the shoulders the back and the arms .
- \_\_\_\_\_ 2. A gymnasium is a good place for sports activities .
- \_\_\_\_\_ 3. Sit-ups and push-ups are good examples of stretching exercises.

**PART B:** Write complete answers to the following questions !

1. What is a gymnasium ?
2. What can people do in a gym ?
3. Why do men lift weights ?
4. What can help everyone to improve posture?

**PART C:** Choose the best answer !

1. Fat people try to \_\_\_\_\_ weight .  
a. gain                      b. strengthen      c. lose      d. develop
2. Sit-ups and push-ups \_\_\_\_\_ muscles.  
a. squeeze      b. break down      c. contain      d. strengthen
3. Some men also \_\_\_\_\_ hard rubber balls to make their wrists strong.  
a. study                      b. lift                      c. build-up                      d. squeeze

**PART D:** Imperatives

Read these sentences .Put a check mark (✓) in front of the correct imperative.

1. My cousin is very fat.  
Tell him what to do!  
 Go to a gymnasium!  
 Go to a restaurant!
2. I would like to do some stretching and pulling exercises .  
Tell me what to do!  
 Try push-ups!  
 Try the hard rubber balls
3. Mr Bahrami wishes to build up his shoulders and arms .  
Tell him what to do .  
 Ride bicycles !  
 Try weight lifting !
4. I think my wrists and fingers are not strong enough .  
Tell me what to do !  
 Squeeze rubber balls !  
 Squeeze balls !

## WORD FORMATION ( I )

<b>STUDY THE EXAMPLES :</b> true	<u>truth</u>
develop	<u>development</u>
examine	<u>examination</u>
depress	<u>depression</u>

Add the appropriate endings to form suitable nouns !

1. tense \_\_\_\_\_
2. improve \_\_\_\_\_
3. circulate \_\_\_\_\_
4. co-ordinate \_\_\_\_\_
5. strong \_\_\_\_\_

<b>STUDY THE EXAMPLES :</b> enjoy	<u>enjoyable</u>
use	useful / <u>useless</u>
hunger	<u>hungry</u>
fame	<u>famous</u>
office	<u>official</u>

Add the appropriate endings to form suitable adjectives !

1. thirst \_\_\_\_\_
2. harm \_\_\_\_\_
3. vary \_\_\_\_\_
4. benefit \_\_\_\_\_
5. nerve \_\_\_\_\_

## WORD FORMATION (II)

Use the appropriate form of the word in the corresponding sentence!

- (benefit) 1. Exercise is \_\_\_\_\_ to everyone.
- (harm ) 2. Smoking is \_\_\_\_\_ to the lungs.
- (depression) 3. Everyone feels \_\_\_\_\_ once in a while .
- (variety) 4. There are \_\_\_\_\_ ways to lose weight or gain it.
- (swim ) 5. Why are \_\_\_\_\_ and tennis good exercises ?

## SENTENCE COMPLETION

Use the words in the box to complete the sentences that follow.  
(There are more words than you need.)

nervous	energy
horizontal	relaxation
healthy	muscle
thirsty	health
essential	heart

1. Those lines are not vertical ; they are \_\_\_\_\_
2. The heart is a \_\_\_\_\_
3. I am \_\_\_\_\_. I want a glass of water .
4. The \_\_\_\_\_ helps circulate the blood .
5. Our coach worries about our \_\_\_\_\_ a lot .
6. Athletes usually burn up a lot of \_\_\_\_\_.
7. \_\_\_\_\_ is necessary for everyone.

## TEST YOURSELF

Use the words in the circle to complete the sentences next to or following each picture!

running                      weight lifter                      wrestlers  
exercising                      push ups                      barbell                      tightened

1. This man is \_\_\_\_\_. In picture c, he is doing \_\_\_\_\_.

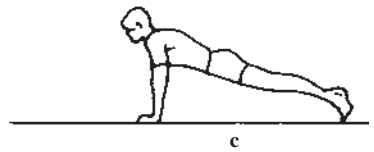
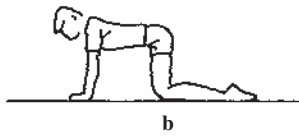
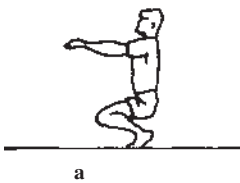

2. The muscles are \_\_\_\_\_ in this type of exercise .





3. This man is a \_\_\_\_\_ . You can see his \_\_\_\_\_ .



4. These men are \_\_\_\_\_ .



5. These two men are \_\_\_\_\_ .

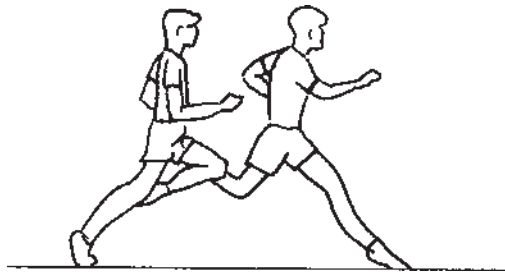

# LESSON TWO



# LESSON TWO

## TRACK AND FIELD (1)

### New Words:

**track and field:** sports that people compete in, such as running and jumping.

**physical education:** lessons in school in which students do physical exercises or take part in physical activities or sports.

**contest:** struggle, competition, fight.

**gymnast:** a person who performs gymnastics especially in competition.

**vaulting:** (also pole vaulting): a field event in which each contestant uses a long pole to vault over a horizontal bar that rests between two upright standards.

**event:** any of individual contests that comprise a sports program.

### Dialogue : An introduction to track and field

Reza : Hi, Ali.

Ali : Hello, Reza. How are you?

Reza : Fine thanks. How about your Physical Education course?

Ali : It's very interesting. The subject for today's class was an introduction Track and Field.

Reza : What is track and field ?

Ali : Track and Field consists of four types of events .

Reza : What are they ?

Ali : Running, jumping, vaulting and weight throwing.

Reza : Is that all ?

Ali : No. We are going to learn more next time.

Reza : OK. Enjoy your course .

Ali : Thanks.

## UNDERSTANDING

**PART A:** Which of the following sentences are true and which are false? Write “ T” or “ F” before the sentence !

- \_\_\_\_\_ 1. Ali and Reza are in the same class .
- \_\_\_\_\_ 2. Track and field is not a type of running.
- \_\_\_\_\_ 3. Reza is going to learn more in his course.

**PART B:** Give oral answers to the following questions!

- 1. What is vaulting?
- 2. Is track and field a course in physical education?
- 3. What are the four types of events in track and field ?

**PART C:** Choose the best answer !

- 1. Ali is a \_\_\_\_\_ student.
  - a. track and field
  - b. physical education
  - c. weight throwing
  - d. physics
- 2. The teacher \_\_\_\_\_ the subject today.
  - a. started
  - b. interested
  - c. enjoyed
  - d. finished
- 3. There are four types of \_\_\_\_\_ in track and field .
  - a. introduction
  - b. course
  - c. subjects
  - d. events

### New Words:

**sprinter:** a person who takes part in a short, fast race.

**sprint:** a short , fast race. ( A 100 meter sprint)

**steeplechase:** a race on a track with some hurdles and a water jump.

**passing zone:** (also exchange zone or take over zone) an area marked in each lane of the track within which the exchange of the baton must take place in a relay race.

**equipment:** the things that are needed for a particular purpose or activity.(We need new equipment for the sports club.)

**fundamental:** serious and very important.

(A fundamental change in the arrangement of the team is needed.)

**distribute:** to place at different points.

(The weight of the table is distributed among the four kegs.)

**disqualify:** prevent somebody from doing something because they have broken a rule. (He was disqualified from the competition for using drugs.)

## The Track Events

The track events are running, sprinting, and hurdling. Some running events such as hurdles and steeplechase require considerable equipment. Some other running events such as sprinting, relays, and distance running, do not.

Sprinting is a basic skill and fundamental to track and field. The runner should be familiar with three main commands: “On your mark”, “Set” and “Go”. For example, to get “Set” means to distribute the weight of the body in the best possible position from which to take off. Concentration should be put on the rear leg and the opposite arm.

There are some basic rules in the track events. In hurdling, for example, the entire body must pass over the hurdle. And in relays we learn that disqualification of one runner disqualifies the entire team. And also the baton must be passed inside the 20 m passing zone.

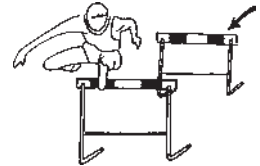

**hurdles**

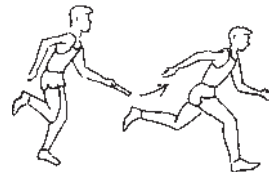

**relays**



**baton**

## UNDERSTANDING

**PART A:** Which of the sentences are true and which are false? Write “ T” or “ F” before the sentences !

- \_\_\_\_\_ 1. Sprinting is a physical activity.  
\_\_\_\_\_ 2. Jumping is not a track event.

**PART B:** Write complete answers to the following questions !

1. What are the different activities of track events ?
2. What are the three commands in sprinting ?

**PART C:** Choose the best answer !

1. The baton must be passed in \_\_\_\_\_.  
a. hurdling            b. relays  
c. sprinting            d. steeplechase
2. Which of the following is **NOT** a command ?  
a. Go                    b. Set  
c. On your mark    d. 20 m passing zone
3. Sprinting requires \_\_\_\_\_ equipment .  
a. no                    b. considerable  
c. little                d. any
4. Which of the following is a basic rule ?  
a. The hurdler can run around a hurdle.  
b. The baton must be passed inside the 20 m passing zone.  
c. Only the first runner of race must have the baton.  
d. Distribute the weight of the body .
5. A synonym for “require” is \_\_\_\_\_.  
a. need                b. rear  
c. depend            d. distribute
6. The antonym of rear in “the rear leg” is \_\_\_\_\_.  
a. in front of        b. ahead  
c. front                d. back

**PART D :** Complete the sentences about the track events .

1. Sprinting , relays, and distance running \_\_\_\_\_

considerable equipment .

2. In hurdling ,the \_\_\_\_\_ body must pass over the hurdle.

3. Sprinting is \_\_\_\_\_ to track and field .

4. “ On your mark ” is a command, the other two are \_\_\_\_\_

and \_\_\_\_\_.

**PART E:** Choose the correct sentence . Put (✓) before the sentence.

1.

a. The runner should be familiar with 3 main commands.

b. To get “set” means to hurdle .

2.

a. In hurdling, the baton must be passed .

b. In relays, the baton must be passed.

3.

a. Hurdles and steeplechase need equipment.

b. A basic skill in running is “On your mark”.

4.

a. In relays, the entire team passes inside the 20 m zone .

b. There are some basic rules in the track events .

5.

a. The track events are running, baton, and sprinting .

b. The track events are sprinting, hurdling, and running.

## VOCABULARY

Fill in the blank spaces using the words in the box!

quickly	to	track	activities
tedious	as	pleasurable	

Sprinting forms an excellent introduction to \_\_\_\_\_ and field program. Although sprinting is a \_\_\_\_\_ activity, repetition can \_\_\_\_\_ make the activity \_\_\_\_\_ ; it is advisable \_\_\_ make sprinting part of other \_\_\_\_\_ and events such \_\_\_ minor games, relays, hurdles, long jumps and triple jumps.

## FREE ACTIVITIES

**PART A : Puzzle .** Fill in the gaps after each statement !

1. The stick carried and passed on by the runners of a relay team:

B \_ \_ \_ n

2. Leaving the starting block or starting line before the gun sounds or making a movement from the set position:

F \_ \_ \_ e s \_ \_ \_ t

3. One of the track events :

H \_ \_ \_ \_ \_ g

4. Preparation of the body through light exercise for more vigorous exercise.:

W \_ \_ m u p

## PART B: TEST YOURSELF

Use the words in the box to complete the sentence(s) under the corresponding picture!

triple	sprinter	running track
starting block	high jumper	
weight throwing	upright	hurdling

1. Identify parts a, b, and c.

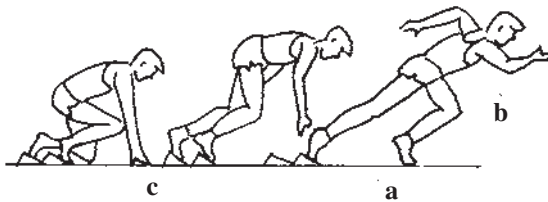

2. This is an example of \_\_\_\_\_.

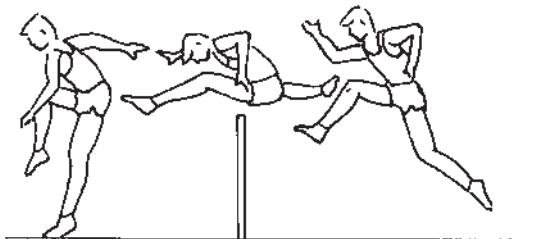



3. The \_\_\_\_\_ is demonstrating shoulder landing .  
The arrow is pointing to the \_\_\_\_\_.

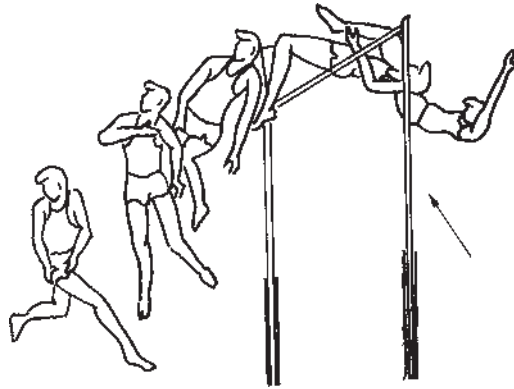

4. This is the \_\_\_\_\_ event .

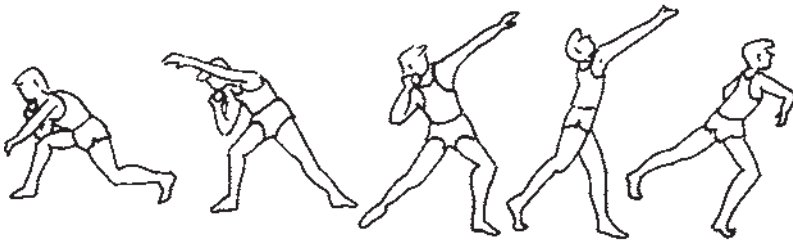

5. This is not the high jump, it is the \_\_\_\_\_ jump.

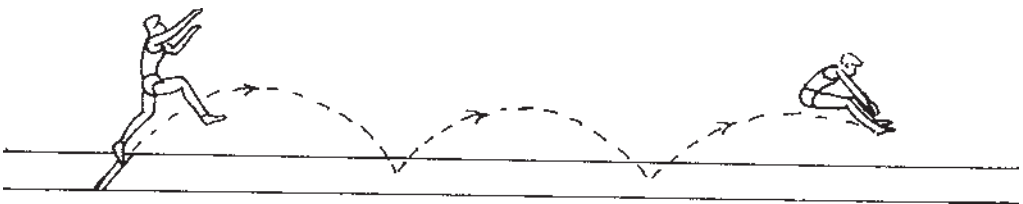

### PART C : TRANSLATION

Translate the following sentences into Persian .

1. The steeplechase is a 3000 meter event for men that includes 28 hurdles jump and 7 water jumps.
2. The sprinter should be relaxed while running to maintain the greatest speed.

# LESSON THREE

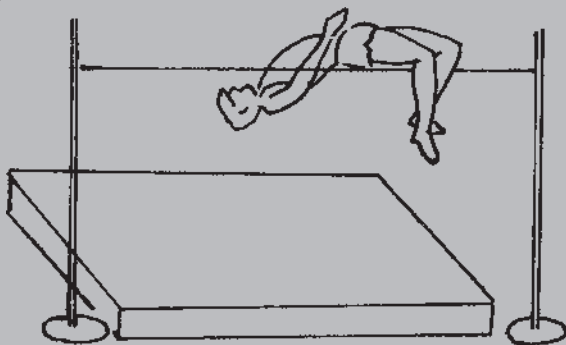
A large, tilted rectangular sign with a double-line border. The sign is mounted on a long, tapered wooden post. The text 'LESSON' and 'THREE' is written in a bold, black, serif font, stacked vertically. The sign is tilted upwards to the right.

## LESSON THREE

### TRACK AND FIELD (2)

#### New Words:

**the triple jump:** a sporting event in which people try to jump as far forward as possible with three jumps. ( Also called hop, step and jump)

**competitor :** a person who takes part in a competition.

**throwing circle:** a circular area in which a competitor must remain during his attempt.

**drag:** move or make something move , partially touching the ground.

(Don't drag your feet on the ground.)

**land:** come on to the ground.

(The hammer landed outside the sector.)

#### Dialogue : What do you know about field events ?

Reza : Hi ,Ali .

Ali :Hi, Reza . How are you today ?

Reza : Fine, thanks . What about your track and field class ?

Ali : I find it interesting and useful .

Reza: What are the field events ?

Ali : Throwing and jumping events ?

Reza: What about some interesting rules ?

Ali : Very many . For example , the foot must not drag during the stop phase of triple jump.

Reza: What about the hammer throw ?

Ali : During the throw the competitor must not leave the circle.

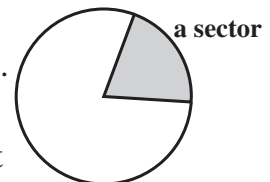
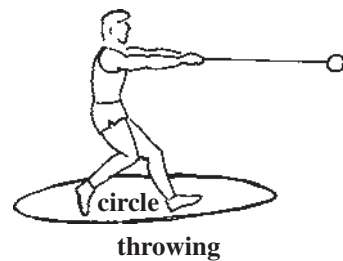

Reza: Yes, and the throw must land within the throwing sector.

Ali : Exactly.

Reza: Ok. Let's go to the long jump and triple jump landing area.

Ali : Ok. Let's go?

### New Words:

**boost:** increase the value or amount of something.

**enthusiasm :** interest or admiration for something.

**lead up activities:** preparatory activities; activities at the beginning of a task.

**run up:** a run made to gain speed for making a jump.

**introductory activities :** lead up activities.

**sprint starts:** a position normally used by competitors at the start of sprint races.

**rate of improvement:** a measurement of the speed at which something becomes better.

(His rate of improvement surprised his coaches.)

### Field Events (A)

The field events are jumping and throwing . The high jump, long jump ,and the triple jump are closely related in that their introductory and lead-up activities are very similar .

Long jump should be one of the first jumping events introduced in the program . It can be taught in combination with triple jump . Instructors can teach these two jumping events immediately after sprinting, sprint starts ,and relays .Many instructors will teach the long jump after the triple jump, for

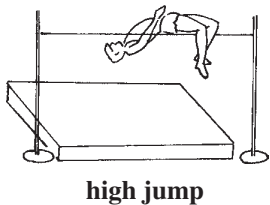

high jump

several reasons. Rates of improvement in triple jump are much higher than for long jump, and this boosts enthusiasm. Also, most youngsters consider the triple jump a lot more fun than the long jump. Finally, the third jump in triple jump is an elementary long jump, and methods of teaching the run-ups are similar for both events.

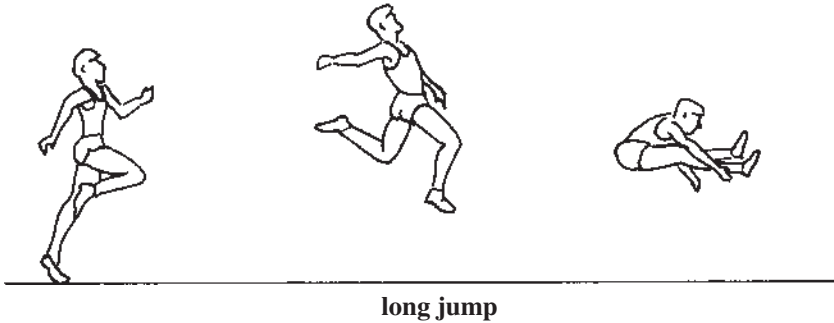

## UNDERSTANDING

**PART A:** Which of the following sentences are true and which are false? Write “T” or “F” before the sentences.

- \_\_\_\_\_ 1. Jumping is a field event, but throwing isn't.
- \_\_\_\_\_ 2. The writer advises the instructor to teach long jump and triple jump after some running events.
- \_\_\_\_\_ 3. The third jump in triple jump is an elementary jump.

**PART B:** Choose the best answer!

1. “The introductory and lead-up activities are similar.”

The word “similar” is the same as \_\_\_\_\_.

- |           |              |
|-----------|--------------|
| a. likely | b. different |
| c. alike  | d. same      |
2. “It can be taught in combination with triple jump. The phrase “in combination with” means \_\_\_\_\_.
- |                   |                     |
|-------------------|---------------------|
| a. separated from | b. together with    |
| c. similar to     | d. independent from |

3. “Instructors can teach these two jumping events immediately”.  
A synonym for “immediately” is \_\_\_\_\_.
- a. right away            b. right now  
c. suddenly              d. hardly
4. “Rates of improvement in triple jumps are higher.” The word  
“improve” means \_\_\_\_\_.
- a. make worse            b. make better  
c. change                 d. prove
5. “...and this boosts enthusiasm”. The antonym of “boosts” is \_\_\_\_\_.
- a. forces                  b. decreases  
c. increases              d. reduces

**PART C:** Write complete answers to the following questions !

1. Mention two field events and two track events.
2. What boots enthusiasm ?
3. What does “ it ” in line 6 refer to ?

**New Words:**

**tremendous:** very great.

**shot put:** a field event in which a shot is thrown for distance.

**coordination:** the act of making things work together.

(A basketball player needs the coordination of eyes and hands.)

**spectacular:** impressive; wonderful to see.

(Our team scored a spectacular goal.)

**resemble:** look like; be similar to another person or thing.

(The child resembled her mother.)

**exceed:** be greater than a particular number or amount.

( Prices will not exceed 10 dollars.)

## Field Events (B)

The modern pole vaulter must be a sprinter, weight lifter and, gymnast. The combination of speed, strength and coordination makes this a spectacular event .

Since the introduction of the fiber-glass pole, tremendously performances have been recorded .

Of all throwing events, the javelin throw most closely resembles the normal throwing action. And because the basic throwing action is less complex than other throwing events, javelin throwing is one of the first throwing events introduced.

Among other throwing events one can mention shot put, discus, as well as hammer throw. The hammer consists of a round weight attached to a triangular handle by a wire. It weights 16 pounds (7.25kg) and its total length may not exceed 48 inches (1.2m). It is thrown from a circle 7 feet (2.13m) in diameter.



javelin  
throw



triangular  
handle

## UNDERSTANDING

**PART A:** Which of the sentences are false and which are true ? Write “ T” or “ F” before the sentence!

- \_\_\_\_\_ 1. A pole vaulter must have all the other skills.
- \_\_\_\_\_ 2. A lot of records changed a little after the vaulters started using fiberglass poles .
- \_\_\_\_\_ 3. Javelin throwing is not a very complex action.
- \_\_\_\_\_ 4. An example of normal throwing is javelin itself.

**PART B:** Write complete answers to the following questions !

1. What are the characteristics of a modern vaulter ?
2. Mention one jumping and one throwing event !
3. What happened after the introduction of fiberglass pole ?

**PART C:** Choose the best answer !

1. A weight lifter \_\_\_\_\_.  
a. lifts weights                      b. weighs lifts  
c. leaves weights                    d. leaves a lift
2. A spectacular event is one that is \_\_\_\_\_ to see.  
a. good                                  b. OK  
c. interesting                          d. hard
3. "Tremendous" is a synonym for \_\_\_\_\_.  
a. great                                  b. small  
c. little                                  d. unimportant
4. "The javelin throw most closely resembles ...". The word "resemble" means "is \_\_\_\_\_".  
a. same as                                b. such as  
c. the same                                d. similar to

**FURTHER ACTIVITIES**

Test yourself

Use the appropriate word to fill the gap under each picture !

bar	glove	vaulter	height scale	handle
upright	box	bar	field	high jumping
grip	landing area		vaulting	hammer head

1. An example of field event is \_\_\_\_\_.  
The arrow shows the \_\_\_\_\_.

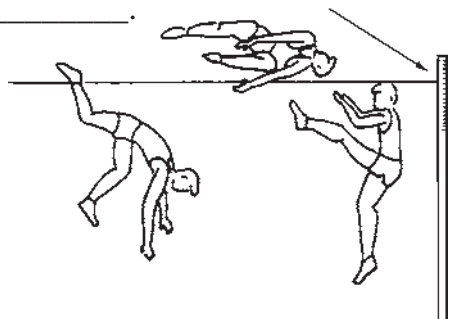



2. The man in the picture is a pole \_\_\_\_\_.  
 A is the \_\_\_\_\_ pole ,and B is the\_\_\_\_\_.

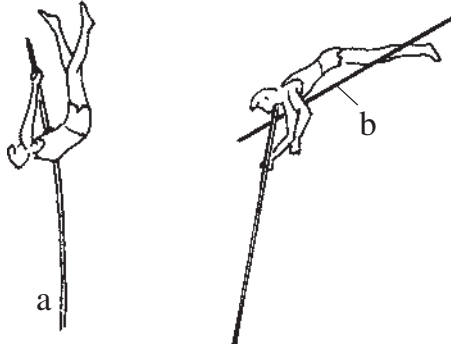

3. Identify the different parts of this high jump equipment.

a. \_\_\_\_\_ b. \_\_\_\_\_  
 c. \_\_\_\_\_ d. \_\_\_\_\_

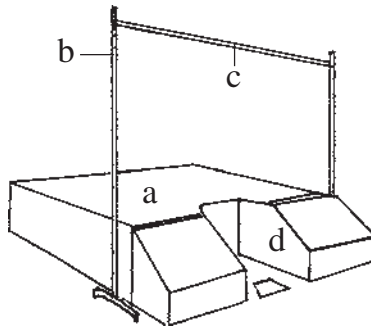

4. Identify parts 1 and 2 !

1. \_\_\_\_\_ 2. \_\_\_\_\_

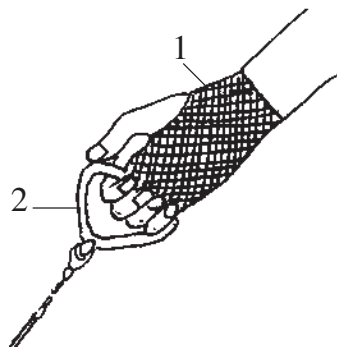

5. These men are demonstrating two \_\_\_\_\_ events.

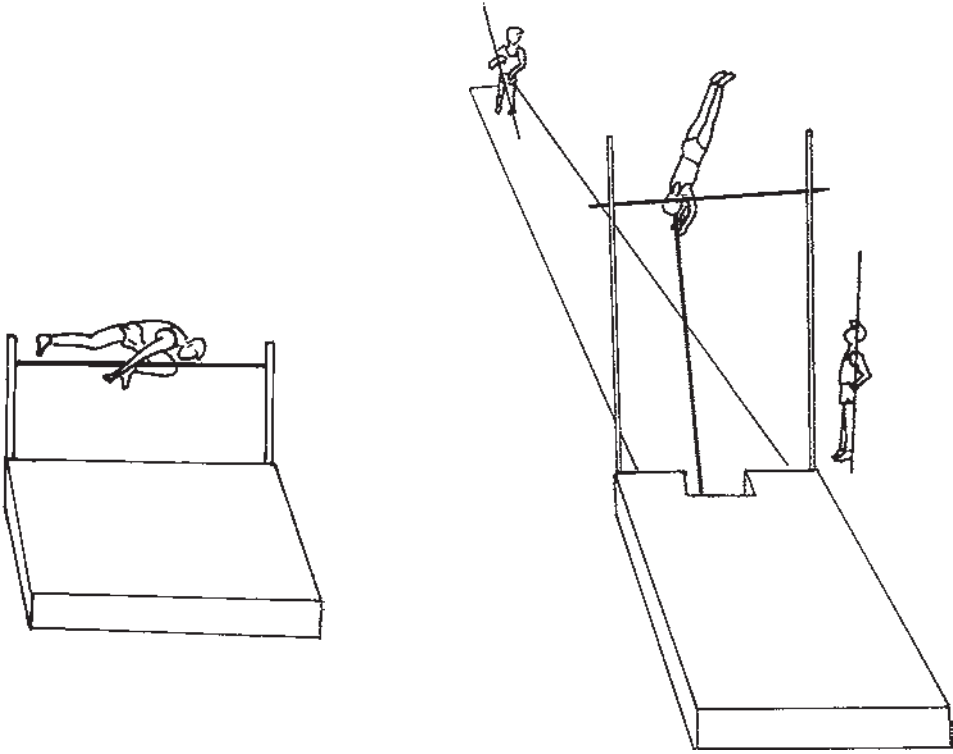

**LESSON  
FOUR**



# LESSON FOUR

## SWIMMING STROKES

### New Words:

**term** :a word or expression ,often used in relation to a particular subject.

(Gliding, floating and strokes are useful swimming terms.)

**technique**: a special way of doing something.

(The swimmer combined different techniques to swim faster.)

**gliding**: moving smoothly and quietly, without much effort.

(The bird was gliding through the air.)

**float**: to stay on top of water.

(Wood floats on water.)

**make progress**: become better.

(Ali has made good progress in his subject this year.)

### Dialogue : At the swimming pool

Akbar : Hello, everybody.

Kamal : Hi, Akbar.

Reza : Hello . How's everything ?

Akbar : Fine. Our swimming instructor taught us some swimming terms and techniques .

Reza : Such as ?

Akbar : Such as gliding ,floating, and strokes.

Reza : I know about gliding and floating, but strokes are new to me.

Akbar : Strokes are the movements of your arms and legs that take you forward in the water.

Kamal : A stroke can also mean the style of swimming.

Akbar : Yes, of course. And there are different types of strokes.  
The most common strokes are the crawl, backstroke, breaststroke, butterfly, and sidestroke .

Reza : It seems you are making good progress in your swimming course .

Akbar : I hope so. I love swimming .

Kamal and

Reza : Good luck. Enjoy your course .

Akbar : Thanks .

## UNDERSTANDING

**PART A :** Write “ T” or “ F” before the following sentences !

- \_\_\_\_\_ 1. Akbar hopes to improve his swimming skills .  
\_\_\_\_\_ 2. Reza thinks Kamal is doing well in his swimming course.  
\_\_\_\_\_ 3. Breaststroke and butterfly are exactly the same.

**PART B :** Complete these short conversations . The words you need are in the dialogue .

1. A: Do you like your swimming course ?  
B: Yes. I think\_\_\_\_\_ .
2. A: Name 3 different types of strokes .  
B: The crawl, the butterfly, and the \_\_\_\_\_.
3. A: Which is the most common type of stroke ?  
B: The \_\_\_\_\_.
4. A: Can you swim the crawl smoothly ?  
B: I \_\_\_\_\_so .
5. A: Are the other students doing well, too ?  
B: Yes. They are making good \_\_\_\_\_ .

### New Words:

**instinct:** a natural tendency that makes people and animals do certain things.

(Most animals swim by instinct.)

**instinctive:** based on instinct.

(Animals have an instinctive fear of fire.)

**afloat:** floating on water.

(He could not swim, and only a life jacket kept him afloat)

**disappear:** to stop existing; to vanish.

(His fear disappeared when he turned on the lights.)

**participate:** to take part in an activity.

(She didn't participate in the contest.)

## SWIMMING

Early man probably learned swimming by observing animals that use a running motion to move about on or in the water. But some scientists believe that human beings are born with an instinctive ability to use their arms and legs to stay afloat. That instinct, however, disappears within a few months after birth. Later in life many children and adults learn to swim in order to be safe around the water, to have fun, and to participate in competitions.

## UNDERSTANDING

**PART A:** Draw a line from a word in column I to a word closest in meaning in column II

- | I              | II                  |
|----------------|---------------------|
| 1. observe     | a. vanish           |
| 2. probably    | b. remain           |
| 3. motion      | c. watch            |
| 4. stay        | d. contest          |
| 5. disappear   | e. movement         |
| 6. participate | f. almost certainly |
| 7. competition | g. take part        |
- 

**PART B:** Which of the following statements are false and which are true ? Write “ T” or “ F” before the statement!

- \_\_\_\_\_ 1. According to the passage not all animals can swim .
- \_\_\_\_\_ 2. Human beings can swim within a few months after birth .
- \_\_\_\_\_ 3. Children and adults learn to swim just for competitions.
- \_\_\_\_\_ 4. There are different reasons for children and adults to learn to swim.

**PART C:** Some of the statements are correct and some are incorrect. Write correct before the correct statements. Correct the incorrect statements.

- \_\_\_\_\_ 1. Some animals can move in or on the water.
- \_\_\_\_\_ 2. According to the passage, scientists are born with an instinctive ability to swim.
- \_\_\_\_\_ 3. Different people have different reasons to swim .
- \_\_\_\_\_ 4. The instinctive ability to stay afloat appears within a few months after birth .

**New Words:**

**recreation:** a particular activity that people do for enjoyment when they are not working.

(His recreations are swimming and photography.)

**competition:** a game that people try to win; a contest.

(He entered the table tennis competition and won the cup.)

**efficient:** doing something well and successfully.

(As we get older, our bodies become less efficient in burning up calories.)

**graceful:** moving in a smooth and beautiful way.

(After long hours of practice, Reza became a graceful swimmer.)

## The major strokes

There are different swimming strokes introduced in a swimming course. Four of the five main swimming strokes are used both in competition and recreation. The fifth major stroke, the sidestroke, is slower than the competitive strokes and is used primarily as a recreational and life-saving technique.

The first major stroke is the crawl which is the fastest and most efficient swimming technique. It is also called the freestyle, because swimmers use it in freestyle events, which allow the use of any stroke. Next, there is the backstroke which is the only stroke that is swum on the back. The third major stroke is the breaststroke. Breaststroke is one of the easiest and most relaxing strokes for beginners. Competitive swimmers, however, find it difficult because it uses more energy than the crawl and backstroke when swum at a fast pace. Finally, there is the butterfly stroke which is powerful, graceful, and fast. More than any other stroke, the butterfly relies on good techniques.



crawl stroke

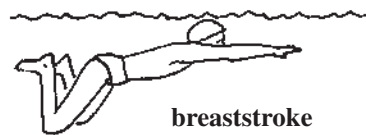

breaststroke



butterflystroke



backstroke



sidestroke



## UNDERSTANDING

**PART A :** Use the words in the box to complete each of the definition given.

breaststroke      The crawl      crawl  
The sidestroke      backstroke

1. The only stroke that is swum on the back : The \_\_\_\_\_
2. The stroke used mainly as a life-saving technique: \_\_\_\_\_
3. The easiest and most relaxing stroke for beginners: The \_\_\_\_\_
4. Also called the free style : \_\_\_\_\_
5. The fastest and most efficient stroke : The \_\_\_\_\_

**PART B :** Put a check mark (✓) before the correct sentence.

1.
  - a. The sidestroke is faster than the competitive strokes.
  - b. The most difficult and exhausting stroke is the butterfly stroke.
2.
  - a. The backstroke is a life-saving technique.
  - b. When swum at a fast pace , the breaststroke uses a lot of energy.
3.
  - a. Not all of the five major strokes are used as a recreation and life-saving technique .
  - b. All of the five main strokes are used both in recreation and competition.
4.
  - a. Butterfly stroke is not powerful or fast .
  - b. Butterfly stroke is quick and powerful .

# GRAMMAR REVIEW

**PART A:** Follow the examples and fill in the boxes .

<b>EXAMPLE :</b> tall	<b>taller</b>	<b>the tallest</b>
careful	<b>more</b> careful	the <b>most</b> careful
difficult	<b>more</b> difficult	the <b>most</b> difficult
good	<b>better</b>	best

Fast	_____	_____
Slow	_____	_____
Free	_____	_____
Easy	_____	_____

Many	_____	_____
Much	_____	_____
Little	_____	_____
Bad	_____	_____

Graceful	_____	_____
Powerful	_____	_____
Relaxing	_____	_____
Competitive	_____	_____
Efficient	_____	_____
Exhausting	_____	_____
Interesting	_____	_____

**Fill in the gaps with the correct form of the adjective.**

1. The breaststroke is one of the \_\_\_\_\_( easy) and \_\_\_\_\_(relaxing ) strokes for beginners .

2. The crawl is the \_\_\_\_\_(fast ) and \_\_\_\_\_(efficient) swimming technique.

3. The sidestroke is \_\_\_\_\_(slow) than the competitive strokes.

4. The \_\_\_\_\_(difficult) and exhausting stroke is the butterfly.

5. Swimming strokes should create the \_\_\_\_\_(little) possible resistance.

### FURTHER ACTIVITIES:

**I-TRANSLATION:** Translate the following sentence into Persian . Use your dictionary for new words.

The average person on the pool deck will not be impressed with the strength of your scissors kick or the length of your breaststroke glide, but will notice immediately how smoothly and easily you swim the crawl.

**II- TEST YOURSELF:** Write the following words under the corresponding pictures!

breaststroke   butterfly stroke   crawl stroke   sidestroke



1. \_\_\_\_\_



2. \_\_\_\_\_



3. \_\_\_\_\_



4. \_\_\_\_\_

# LESSON FIVE

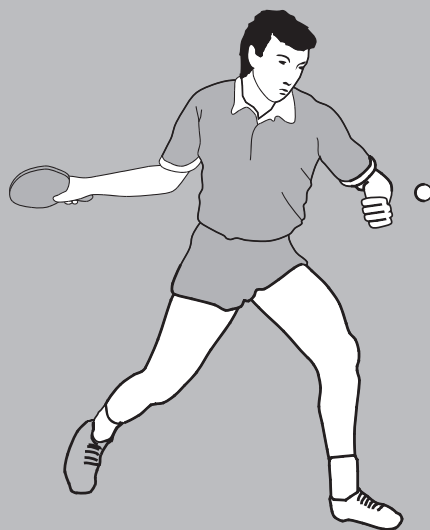

# LESSON FIVE

## TABLE TENNIS

### New Words:

**review** : go over.

**regular** : evenly or systematically arranged.

**regularly**: state of being regular.

**tight** : fixed ,fastened , or drawn together firmly.

### Dialogue :Let's review some points.

Mina : Hello.

Zahra: Hi. How are you today?

Mina : Fine ,Thanks. I am going to have a test on table tennis today.

Zahra: Why don't you review some skills and techniques before the exam?

Mina : I've already practiced different types of grips.

Zahra: Do you mean shake hand and penholder grips ?

Mina : That's right. By the way, did you know that shake hand grip is also called the western grip?

Zahra: No, I didn't. Anyway , remember: Do not grip the racket too tightly .

Mina : I'll try to remember that.

Zahra: One more thing. Regularly check the thumb and index finger to keep them in the proper place .

Mina : Thank you very much .

Zahra: You're welcome .Good luck .

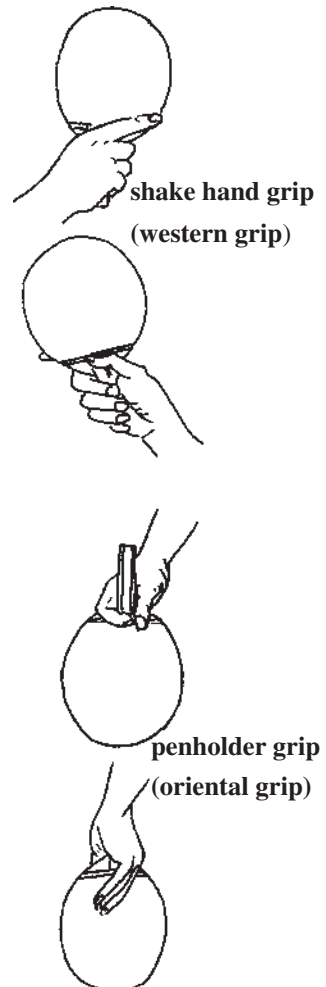

## UNDERSTANDING

**PART A:** Which of the following sentences are true and which are false. Write “T” or “F” before the sentences.

- \_\_\_\_\_ 1. The thumb and index finger are very important in gripping the racket.
- \_\_\_\_\_ 2. The shake hand grip is the same as western grip.
- \_\_\_\_\_ 3. You must grip the racket very tightly.

**PART B:** Fill in the gaps. Use the words and expressions appeared in the dialogue.

- 1. There are two main types of grip in table tennis, \_\_\_\_\_ and \_\_\_\_\_.
- 2. You have to check your \_\_\_\_\_ and \_\_\_\_\_ finger regularly when playing table tennis.
- 3. In table tennis you need some \_\_\_\_\_ and skills.

### New Words:

**back and forth:** from one place to another and back again repeatedly.

**miss :** to fail to hit, catch, or reach.

**successive:** coming one after the other in an unbroken rally.

**popular:** liked by many people.

(Football is a very popular game in Iran.)

**popularity:** Being liked by a lot of people.

( The reason for popularity of football is that it is a very exciting sport.)

**indoor:** done or used inside a building.

(An indoor swimming pool is much more expensive.)

**outstretched:** stretched or spread as far as possible.

(He balanced himself with outstretched arms.)

**strike :** Hit.

(The football player struck the ball beautifully.)

## TABLE TENNIS

Table tennis, also called Ping-Pong, is an excellent home game for the entire family. One of the reasons for its popularity is that persons of any age and either sex can play the game all the year round. It is usually played indoors , by two or four players .



**a feather**

Table tennis causes little or no damage or injury indoors because a small racket and a 'light as a feather' ball are used. The ball is 40mm in diameter and 2.7g in weight .

Table tennis involves hitting the ball back and forth over the net until one of the players misses the ball, or hits it into the net or off the table. In each of these cases the opponent scores a point. To serve properly , a player holds the ball on the flat ,outstretched palm of the hand then throws it up and strikes it as it falls. The ball must then hit the table on server's side of the net first and then play continues as in tennis, but the ball must hit the table before being returned by a player.

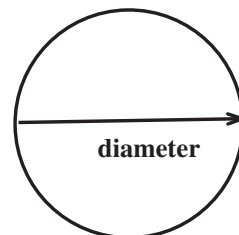

**diameter**

One player serves until 2 points have been scored, after which the opponent serves for the next 2 points. A game is won by the player who first scores 11 points, unless both players have scored 10 points, in which case the one who first scores 2 successive points more than the opponent is the winner.



**a flat palm**

## UNDERSTANDING

**PART A:** Which of the following sentences are true and which are false . Write “ T” or “ F” before the sentences.

- \_\_\_ 1. Table tennis is different from Ping-Pong.
- \_\_\_ 2. Both sexes can play the game.
- \_\_\_ 3. During the game, if you score two points more, you are the winner.
- \_\_\_ 4. The racket is 40 mm in diameter.
- \_\_\_ 5. “ It” in line 5 refers to table tennis.

**PART B:** Give oral answers to the following questions !

- 1. Why is table tennis so popular ?
- 2. What does “entire” mean in line 2 ?
- 3. How old are the people who play table tennis ?
- 4. Who is the winner?

**PART C:** Read the following statements carefully. Some of these sentences are correct, and some are incorrect. Write **correct** next to the correct sentences. Correct the incorrect sentences.

- \_\_\_ 1. Table tennis involves hitting the table back and forth.
- \_\_\_ 2. The opponent scores a point if the other players misses the ball.
- \_\_\_ 3. Table tennis causes a little or some damage indoors.
- \_\_\_ 4. You win the game if you first score 21 points.
- \_\_\_ 5. To serve properly, a player holds the ball on the flat open palm ,then throws it up and strikes it as it falls.

**PART D:** Use the words in the box to complete the sentences that follow.

lightweight    net    forth    excellent    diameter

- 1. The ball is 40 mm in \_\_\_\_\_.
- 2. Tennis is a(n)\_\_\_\_\_ home game for all the members of the family.



3. To play table tennis you need a small racket and a \_\_\_\_\_ ball.
4. If a player hits the ball into the \_\_\_\_\_ , the opponent scores a point.
5. Table tennis involves hitting the ball back and \_\_\_\_ over the net.

**PART E:** Use the words in column B closest in meaning with the words in column A . Write a,b,c,...etc. in the spaces.

_____ A _____	_____ B _____
1. properly     ()	a. strike
2. hold         ()	b. correctly
3. hit           ()	c. keep
4. go back     ()	d. if not
5. whole       ()	e. return
6. unless      ()	f. entire

**PART F:** Match the word in the box with the definition given!

miss      properly      grip      return  
 popular    opponent      successive

1. liked by many people : \_\_\_\_\_
2. correctly : \_\_\_\_\_
3. person who is against another person in a fight or game : \_\_\_\_\_
4. take and keep a firm hold of something or someone : \_\_\_\_\_
5. coming one after the other in an unbroken series : \_\_\_\_\_
6. send back : \_\_\_\_\_
7. to fail to hit ,catch or reach : \_\_\_\_\_

# LESSON SIX



# LESSON SIX

## SOCCER (FOOTBALL)

### New Words:

**kicking:** driving a ball by hitting it with the foot.

**dribble:** to move or advance the ball along the ground with successive light kicks.

**defense\*:** the act of protecting somebody or something.  
(Soldiers died in defense of their country.)

### Dialogue : Some skills and rules

Instructor: Hello, class.

Students : Hello, sir.

Instructor: Today, we are going to review some skills and rules in soccer, or football. Ali, what are the basic skills in soccer?

Ali : Kicking, dribbling, passing, heading, trapping ...

Instructor: And tackling. Very good. Nader, what is tackling?

Nader : It's trying and taking the ball from the opponent. It is the primary tool of defense.

Instructor: Thank you. Amir, can players wear protective equipment ?

Amir : Well.... yes. Soccer rules require players to wear only one piece of equipment, shin guards.

Instructor: Thank you Amir. Ali, can you tell us about offsides?

Ali : Yes. Ah.... Um.... I know it but it is hard to explain.

Instructor: OK, class. I'll tell you another major rule in soccer. Listen carefully.

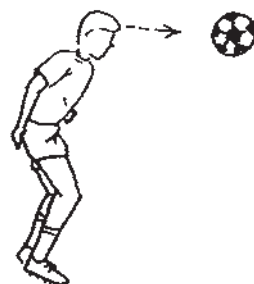

heading



trapping



shin guards

\* "Defense" is also spelled "defence."

## UNDERSTANDING

**PART A :** Which of the following sentences are false and which are true? Write “ T” or “ F” before the sentence!

- \_\_\_\_\_ 1. Football players use five basic skills.  
\_\_\_\_\_ 2. An important skill used in defense is tackling.  
\_\_\_\_\_ 3. Football players can wear different pieces of protective equipment.

**PART B:** Put a check mark (✓) before the correct answer!

1. Soccer is a \_\_\_\_\_  
a.  game  
b.  play
2. Kicking is a soccer \_\_\_\_\_  
a.  skill  
b.  rule
3. Shin guards are protective \_\_\_\_\_  
a.  equipment  
b.  skills
4. Tackling is a defense \_\_\_\_\_  
a.  rule  
b.  tool

### New Words

**commit: (v)**, to do (something wrong or illegal).

**defend: (v)**, to keep safe from harm.

They defended their goal with great skill.

**defensive: (adj)**, used for defending; e. g. defensive tactics, a defensive position.

**forward: (adj)**, directed or moving toward the front.

A forward pass moves the ball nearer to the goal.

**infraction: (n)**, the breaking of a rule or law.

**infringe: (v)**, to go against a law, etc.

to take over (the right of another person).

**interfere: (v)**, to get in the way of; prevent from working or happening.

**involve: (v)**, to cause (someone or oneself) to become connected or concerned in; to have as a necessary part or result.

**offense: (n)**, (also spelled offence) an act of wrongdoing, esp. of breaking the law offensive (adj), causing offence: unpleasant; e. g. offensive remarks.

**penalize: (v)**, (also spelled penalize) to punish (a team or player) by giving an advantage to the other team, esp. by giving the other team penalty.

**prohibition: (n)**, a rule that stops something being done.

A prohibition against touching the ball with hands.

**sanction: (n)**, a formal action or punishment (to be) ordered when a law or rule is broken.

## OFFSIDE

One of the major rules in soccer, in addition to prohibition against striking the opponent and touching the ball with hands, is the rule of offside.

Offside is defined as: infraction in which an offensive player does not have at least two defensive players between himself and the goal line when the ball is played forward by a member of the attacking team.



a goal keeper

## OFFSIDE RULE

It is **not** an offence in itself to be in an offside position.

A player is in an offside position if:

- He is nearer to his opponents' goal line than both the ball and the second last opponent

A player is **not** in an offside position if:

- He is in his own half of the field of play
- He is level with the second last opponent
- He is level with the last two opponents

## Committing an offside offence

A player in an offside position is only penalized if, at the moment the ball touches or is played by one of his team, he is, in the opinion of the referee, involved in active play by:

- Interfering with play
- Interfering with an opponent
- Gaining an advantage by being in that position

## No Offence

There is no offside offence if a player receives the ball directly from:

- A goal kick
- a throw - in
- A corner kick

## Infringements / Sanctions

For any offside offence, the referee awards an indirect free kick to the opposing team to be taken from the place where the infringement occurred.

Now let's make this easy with some pictures:

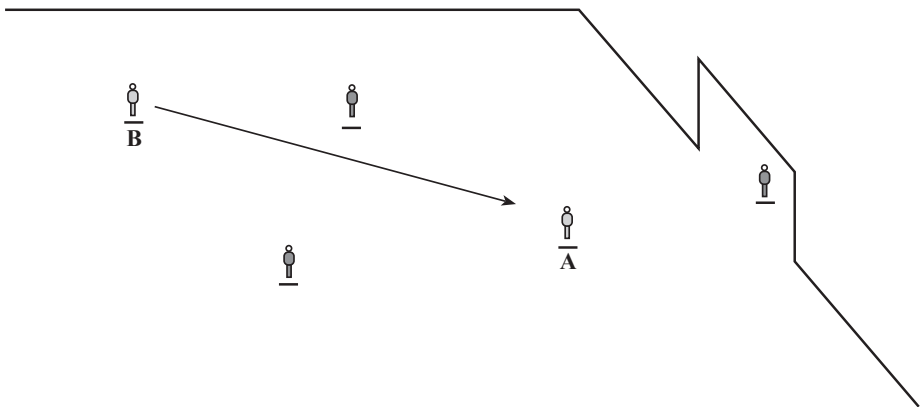

**Question:** How many opposition players are there between player “A” and the goal line when the ball is played forward by player “B”?

**Answer:** One, the goalkeeper.

So player “A” is offside. There needs to be at least two opposition players between “A” and the goalkeeper when B plays the ball forward.

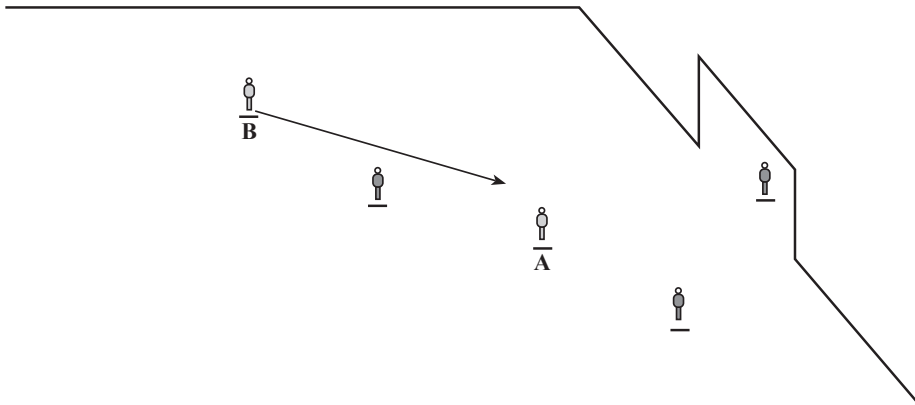

**Question:** Is player “A” still offside?

**Answer:** No, because there are two opposition players between “A” and the goal line when the player “B” plays the ball forward.

**PART A: Write “T” or “F” before the sentences!**

1. The offensive player is penalized if he is in his own half of the field.
2. The indirect free kick is always given to the opposing team from the center of the field.
3. A direct corner kick doesn’t cause an offside offence.

**PART B: Choose the best answer!**

1. There ..... rule(s) in soccer.
  - a. is just one major
  - b. are several
  - c. are only three
  - d. are no major

2. A player is ..... if he breaks a rule.
  - a. awarded
  - b. defensive
  - c. punished
  - d. offside
3. Touching the ball with the hand is ..... .
  - a. offside
  - b. a major rule
  - c. an infraction
  - d. striking the opponent
4. Striking the opponent is ..... in soccer.
  - a. an indirect kick
  - b. a free kick
  - c. a rule
  - d. prohibited
5. If the attacker receives the ball from a throw - in, he is ..... .
  - a. not offside
  - b. offside
  - c. infringing
  - d. awarded
6. Any offside offence means a(n) ..... .
  - a. direct free kick given to the defensive team
  - b. indirect free kick awarded to the goal keeper
  - c. advantage for the offensive team
  - d. advantage for the member of the attacking team

### **New Words:**

**basic:** most necessary or important.

**particular:** special.

**endurance :** the ability to continue doing something difficult for a long period of time.

**cardiovascular :** relating to the heart and blood vessels.

(The old man is suffering from a cardiovascular disease.)

**athletic:** relating to sports.

(He is a member of the most famous athletic club.)

**muscular:** of or relating to muscles.

(He has a very muscular body.)

**elementary school:** a school for children between the ages of 6 and 12.

( He went to elementary school in Shiraz.)



## The importance of soccer

Soccer should be taught in every basic physical education program from elementary school up through high school and college if for no other reason than to teach boys and girls the skillful use of their legs. Soccer is a running game and thus it helps develop cardiovascular endurance. Little equipment is required, making soccer one of the least expensive athletic activities.

No particular body size or physical build is necessary. Training for and playing soccer develop leg strength, body coordination, speed, and muscular endurance. The game can be played equally well by both sexes.

### UNDERSTANDING

**PART A:** Which of the following sentences are true and which are false? Write “T” or “F” before the sentence !

- \_\_\_\_\_ 1. There is only one reason to teach soccer in the schools.
- \_\_\_\_\_ 2. Soccer is good for one’s health .
- \_\_\_\_\_ 3. Soccer players should have certain body size .
- \_\_\_\_\_ 4. Only boys can play the game.

**PART B:** Choose the best answer !

- 1. The word “it” in line 6 refers to \_\_\_\_\_.
  - a. reason
  - b. soccer
  - c. teaching boys
  - d. a running game
- 2. Among the advantages of soccer we can mention\_\_\_\_\_.
  - a. body coordination
  - b. running game
  - c. playing soccer
  - d. skillful use

3. Soccer can be taught at \_\_\_\_\_ levels in physical education program.

- a. school
- b. two
- c. almost all
- d. college

**WORD FORMATION :** Study the following examples !

**EXAMPLES:**

athlete	athletic
help	helpful
act	active
nation	national

Use the suffixes in the box to change the following nouns into adjectives!

-ic   -al   -ful   -ive

- |                  |                   |
|------------------|-------------------|
| 1. base _____    | 5. politics _____ |
| 2. skill _____   | 6. hope _____     |
| 3. physics _____ | 7. protect _____  |
| 4. origin _____  | 8. act _____      |

Study the following examples :

**EXAMPLES :**

move	movement
protect	protection
important	importance
inform	information
read	reading

Use the suffixes in the box to change the following verbs into nouns !

-ance   -ment   -ion   -ing   -ation

- |                   |                      |
|-------------------|----------------------|
| 1. equip _____    | 2. build _____       |
| 3. develop _____  | 4. co-ordinate _____ |
| 5. direct _____   | 6. train _____       |
| 7. endure _____   | 8. run _____         |
| 9. prohibit _____ | 10. educate _____    |

## **FREE ACTIVITIES:**

**WORD FORMATION:** Write the correct form of the word in the gap.

1. Soccer requires little \_\_\_\_\_ (equip).
2. Body \_\_\_\_\_ (co-ordinate) is important in soccer.
3. Soccer develops \_\_\_\_\_ (muscle / endure).

## **Free Reading**

Read the following passage carefully. Then draw a football playground. Put the measurements on your drawing.

### **THE FIELD**

Soccer is played on a rectangular field not more than 110 nor less than 100 meters in length . The width should not be more than 75 nor less than 64 meters.

The side field boundary lines are called touchlines. Corner flags not less 1.5 meters high are placed at each corner . At each corner of the field a quadrant with a one-meter radius is drawn. Corner kicks are taken from this area.

In front of each goal a goal area is drawn, 5.5 m. along the goal line from each goalpost and 5.5 m. into the field of play . A large area is also marked out in front of each goal 16.5 m. along the goal line from each goalpost and 16.5 m. into the field. This is called the penalty area. Within each penalty area a penalty mark is made 11 m. from the midpoint between the goalposts and equidistant to them. An area is drawn 9.15 m. using the middle of the penalty kick mark as the center . In addition the field has a centerline (or halfway line) drawn across it and a center circle with a 9.15 m. radius.

# LESSON SEVEN

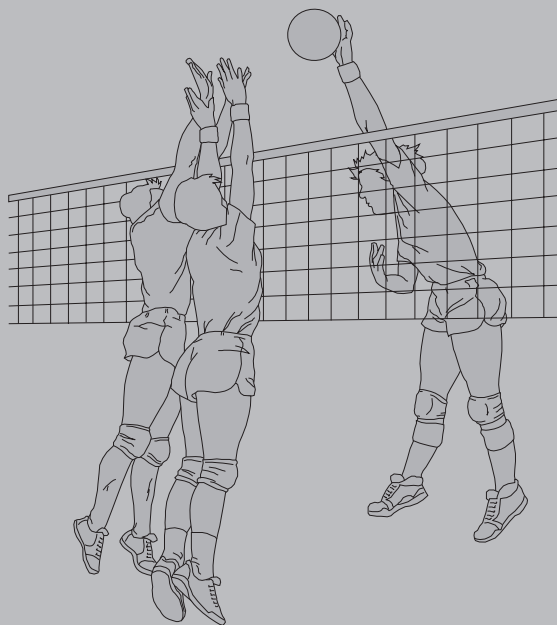

# LESSON SEVEN

## VOLLEYBALL

### New Words :

**substitution:** the replacing of one or more players in the game by other players on the team.

**injury:** damage to the body of a player.

**rotation:** the action of players moving in a clockwise direction when regaining the serve.

**shifting:** moving from one position or place to another.

### Dialogue : Some useful expressions in volleyball

Marjan : Could I ask you some questions ?

Solmaz : What are they about ?

Marjan : Some terms in volleyball .

Solmaz : Please go ahead .

Marjan : What is “ time-out” ?

Solmaz : Stopping the game for rest, substitution and injuries

Marjan : Thanks. What about “dead ball”?

Solmaz : It means the ball that is out of play.

Marjan : And what is “rotation” ?

Solmaz : It means shifting positions clockwise just before the next person serves.

Marjan : Thank you very much .

Solmaz : Not at all .

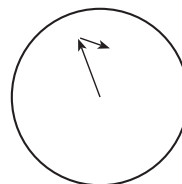

clockwise rotation

### UNDERSTANDING

**PART A :** Which of the following sentences are false and which are true ? Write “ T” or “ F” before the sentence !

- \_\_\_\_\_ 1. Terms refer to some words or expressions .
- \_\_\_\_\_ 2. “To rotate” means to shift position .
- \_\_\_\_\_ 3. A dead ball is not a good ball .

\_\_\_\_\_ 4. There is a “time-out” only when the teams change members.

**PART B :** Read the dialogue again to answer the following questions !

1. Which word in line 1 is the opposite of answer ? \_\_\_\_\_
2. Which word in line 3 means words and expressions ? \_\_\_\_\_
3. Which expression in line 4 means continue ? \_\_\_\_\_
4. Which word in line 10 means changing ? \_\_\_\_\_
5. Which word in line 10 is the opposite of after ? \_\_\_\_\_

**PART C :** Use the halves in column II to complete the conversation started in column I ! Write a ,b,c,..etc. in the spaces provided !

**I**

Hi. How are you today ? ( )  
I'm fine. What's this ? ( )  
What are they about ? ( )  
How many are they ? ( )  
Please, tell me 2 of them. ( )  
Dead ball ? What's that ? ( )  
Well, thank you very much. ( )

**II**

a. You're welcome.  
b. Rotation, and dead ball.  
c. Fine thanks, and you?  
d. A list of expressions.  
e. Ball that is out of play.  
f. They're about volleyball.  
g. About twenty.

**New Words:**

**overlap:** when two things overlap, part of one thing covers part of another thing.

**contact:** the act of touching something.

**replace:** to be used instead of something or somebody else; put a new or different person or thing in the place of another.

**report:** to give somebody information that you have done, heard or seen something.

**scorer:** someone who records the score of a game or contest as an official or under the direction of the chief official.

**original:** first ;earliest.

**remove:** take somebody or something away or off.

**permission:** allowing somebody to do something.

(The referee gave me permission to leave the court.)

## Players and Substitutes

In official matches each volleyball team must consist of only six players. Player positions along the net are: right front, center front and left front; those in the backcourt are called right back, center back, and left back.

When the ball is served, players must be in their positions. In the front line the center front must be between the right and left fronts. In the back line the center back must be between the right and left backs. Also, the back row players may not overlap with the front line players. As soon as the serve is contacted, players may move anywhere on their side of the court.

A substitute may replace any player when the ball is dead, provided the player reported to the scorer and received permission of the referee. A player taken out of the game may reenter once but must return to the original position in the serving order.

A substitute who enters the game and is then removed cannot reenter until the next game.



overlap

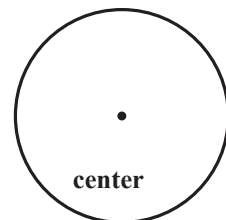

center

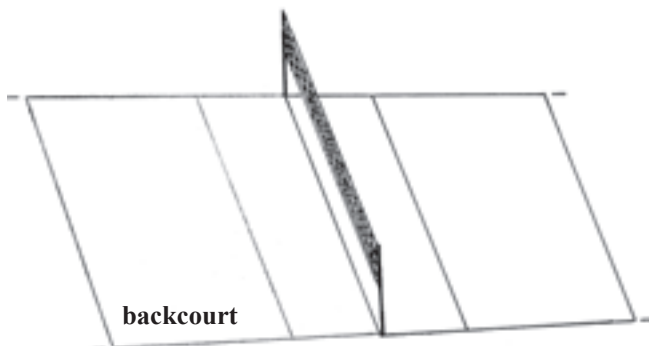

backcourt

## UNDERSTANDING

**PART A :** Which of the following sentences are false and which are true. Write “ T” or “ F” before the sentence!

- \_\_\_\_\_ 1. In any volleyball match there must be six players in each team.
- \_\_\_\_\_ 2. The substitute must have the scorer’s permission.
- \_\_\_\_\_ 3. When the ball is dead, players must be in their positions.
- \_\_\_\_\_ 4. A substitute cannot enter and reenter in the same game.

**PART B :** Put a check mark(✓) next to the correct answer !

- 1. There are six players in each team .  
Each team \_\_\_\_\_ six players .
  - a. consist
  - b. has
- 2. A substitute may replace any player when the ball is dead.  
S/he may \_\_\_\_\_ the court .
  - a. enter
  - b. leave
- 3. A substitute has to get the referee’s permission.  
S/he \_\_\_\_\_ the referee’s permission.
  - a. needs
  - b. returns
- 4. Players must be in their positions when the ball is served.  
They must be in their \_\_\_\_\_ .
  - a. court
  - b. places
- 5. A substitute cannot enter the same game again.  
S/he cannot \_\_\_\_\_ the same game.
  - a. replace
  - b. reenter



**PART C :** Use the most appropriate words in the box to complete the sentences that follow!

return	served	positions
serving	team	serve

1. Three forwards and three backs compose a volleyball\_\_\_\_\_.
2. The ball is \_\_\_\_\_from behind the back line of the court.
3. Teams must \_\_\_ the ball without allowing it to touch the court.
4. Only the \_\_\_\_\_team scores points.
5. If the receiving team wins the volley, it gains the next\_\_\_\_\_ after the players rotate their \_\_\_\_\_clockwise.

### **FREE ACTIVITIES**

Translate the following into Farsi !

In volleyball, spiking is the game’s most dramatic offensive maneuver, occurring when a player drives the ball forcefully downward into the opponents’ court with an open hand at speeds of about 100 mph\*. Defenses attempts to block spikes at the net .

---

\* mile per hour

# LESSON EIGHT



# LESSON EIGHT

## BASKETBALL

### New Words:

**guarding** : attempting to prevent an opponent from playing effectively or from scoring.

**offense** : the act of attacking an opponent or of attempting to score points in a contest.

**defense** : the act of attempting to protect one's side from an opponent's attack.

**Don't mention it** : used as a polite answer when somebody has thanked you for something.

(:Thanks for all your help.

Don't mention it.)

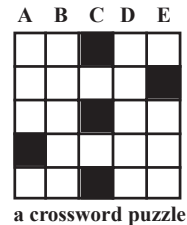

### Dialogue: Crossword puzzle

Karim: Hi. You look busy .

Sina : Hi, Karim . This is a crossword puzzle .

Karim: I really like doing crossword puzzles .

Sina : OK. Maybe you can help me with some questions .

Karim: Go ahead.

Sina : Let's see . Yes. Number one: The game that involves two five-player teams that play both offense and defense.10 letters.

Karim: Two five-player teams / offense and defense. Is it basketball ?

Sina : Yes. There are ten letters in the word "basketball".

Karim: What about the next one ?

Sina : Number five down : One of the basic offensive skills in Basketball.

Karim: Is it "shooting" ?

Sina : No. The word starts with p .

Karim: Is it “passing” ?

Sina : Fine. There is one more : The basic defensive technique in basketball.

Karim: Is it “guarding”?

Sina : Yes. Well, thank you very much .

Karim: Don’t mention it .

## UNDERSTANDING

**PART A :** Which of the following sentences are true and which are false. Write “ T” or “ F” before the sentence !

- \_\_\_\_\_ 1. In basketball ,the players only defend .  
\_\_\_\_\_ 2. Guarding is a basic offensive skill .  
\_\_\_\_\_ 3. As an offensive skill ,one can mention “shooting”.

**PART B:** Use the halves in column B to complete the sentences in column A!

Note : There is an extra half in column B

A	B
1. There are five players ..... ( )	a. in a basketball game
2. Offensive is ..... ( )	b. both among offensive skill
3. “Passing”,and“shooting”are...( )	c. in a basketball team
	d. the opposite of defensive

### New Words:

**jump ball:** A method of putting the ball in play that consists of the referee’s tossing the ball

**overtime :** an extension of the playing time to decide a winner.

**line up :** to get into form in a line; to take one’s position in.

**midcourt :** the area of the basketball court just on either side of the division line.

**regain :** to get back

**score:** (n) the number of points, goals, etc. each player or team gains.

**score :** (v) to make a score in a game or contest.

**points :** the basic scoring unit in most games.

**make a basket:** ( also shoot a basket) to gain a point by throwing the ball through the basket net.

**shot :** the throwing or propelling of the ball toward the basket.

**foul :** against the rules of the game.

**tie :** to make one's score equal to the opponent's score.

## **Basketball**

The basketball game involves two five-player teams that play both offense and defense. At the completion of each game, the team that has scored the most points wins. When a game is tied after regulation time has ended , the teams play overtime periods until one team ends an overtime period with more points and is therefore the winner.

Every game begins with a jump ball at the center of the court. With one player from each team lined up in the midcourt circle, a referee tosses the ball high into the air, and the two players attempt to direct the ball to one of their own teammates. The team that gains possession plays offense, and the opposition plays defense, protecting its own basket until it regains possession of the ball .

There are two ways an offensive team can score points . The first way to score is to make a basket, which is worth 2 or 3 points, depending on the distance of the shot. The second way to score is a foul shot, also called a free throw. These are awarded to a player when the opposition commits a personal foul ( illegal contact such as pushing, holding, charging , or tripping ) or a technical foul (violation of the rules without physical contact, such as unsportsmanlike conduct).

## UNDERSTANDING

**PART A :** Which of the following sentences are false and which are true ? Write “ T” or “ F” before the sentence !

- \_\_\_\_\_ 1. When the game is tied ,the referee stops the game .
- \_\_\_\_\_ 2. Not every game begins with a jump ball.
- \_\_\_\_\_ 3. Pushing , holding or tripping are technical fouls.
- \_\_\_\_\_ 4. The distance of the shot is important in gaining the points.

**PART B :** Use the halves in column B to complete the sentences in column A.

Write a,b,c, etc in the spaces provided

**A**

**B**

- |   |                                  |
|---|----------------------------------|
| _____                                       | _____                            |
| 1. A winner team is .....( ).               | a. the referee tosses the ball.  |
| 2. Sometimes the teams have to play... ( ). | b. the other team plays defense. |
| 3. At the beginning of the game .....( ).   | c. overtime periods.             |
| 4. One team plays offense,..... ( ).        | d. is a technical foul.          |
| 5. An unsportsmanlike conduct..... ( ).     | e.the team that scores the most. |

**PART C:** Choose the best answer !

- 1. One way to score is to \_\_\_\_\_.
  - a. make a basket
  - b. end an overtime period
  - c. involve two teams
  - d. commit a personal foul
- 2. An example of personal foul is \_\_\_\_\_.
  - a. pushing
  - b. jumping
  - c. shooting
  - d. scoring
- 3. In the jump ball each player tries to \_\_\_\_\_ the ball to a member of his/her team.
  - a. play
  - b. send
  - c. attempt
  - d. gain

4. The team playing defense has to \_\_\_\_\_ its basket .
  - a. protect
  - b. point
  - c. push
  - d. play
5. For a jump ball the referee invites \_\_\_\_\_ player(s) from each team.
  - a. one
  - b. two
  - c. no one
  - d. someone

**PART D:** Use the most appropriate words in the box to complete the sentences that follow !

Note: There are some extra words in the box.

violate	winner
different	score
an offensive	tied

1. There are two ways for \_\_\_\_\_ team to score points .
2. Foul shots are not awarded to players who \_\_\_\_\_ the rules.
3. Sometimes teams have to play overtime periods in order to determine the \_\_\_\_\_.
4. Personal fouls are \_\_\_\_\_ from technical fouls.

### Free Activity

**Read the following and try to translate it into Farsi!**

#### Fundamental skills and techniques

#### Passing

Passing is the key to successful basketball . A successful team must be able to handle, control, and move the ball downcourt quickly and accurately to create scoring opportunities .

First, learn to catch as well as pass. When the ball is thrown to you ,spread the fingers but keep them relaxed . When the ball hits the fingers ,let the arms give slightly toward the body. When the ball is under control, finger it into passing position by placing the hands on each side of the ball so that you can get it away quickly or get set for a shot.



# LESSON NINE



## LESSON NINE

# THE OLYMPIC GAMES

### New Words:

**unscramble:** to arrange something that is confused or in the wrong order in a clear, correct way.

**boycott :** to refuse to buy, use or take part in something.

**peace:** a period of time in which there is no war or violence in a country or an area.

**amateur :** a person who takes part in sports or other activities for enjoyment or interest, not as a job.

### Dialogue: let's unscramble words!

Azadeh : Hello, Maryam; Hello Parvin.

Maryam and Parvin: Hello Azadeh.

Azadeh : What's this? A crossword puzzle?

Maryam : It is not a crossword puzzle.

Parvin : We are unscrambling some words to find the hidden words.

Azadeh : I see you've unscrambled nationals, boycott, peace, skiing and compete.

Parvin : Yes. We have only two more left. Would you like to join us?

Azadeh : Sure.

Maryam : The first one reads as amsureat (8 letters). The clue is : The competitors must not be "professionals". They must be\_\_\_\_\_.

Azadeh : Excuse me , Parvin . What is the opposite of "professional" ?

Parvin : Is it amateur ?

Azadeh : Exactly. And the plural form of the word is "amateurs" which is 8 letters.

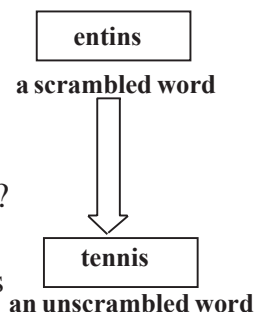

Maryam : That's fine. Now . The second one reads as steelhat (8 letters).The clue is :People who play sports well:\_\_\_\_\_

Azadeh : Is that "athletes"?

Maryam : Yes. Now ,let's find the hidden words.

## UNDERSTANDING

Unscramble the words, put them in the corresponding boxes, and then find the hidden words:

naalstoin	n	a	t	i	o	n	a	l	s
		9			1				
steelhat				2					12
bootcy	b	o	y	c	o	t	t		
			3						
amsureat		4							
pceea	p	e	a	c	e				
		5			11				
skgnii	s	k	i	i	n	g			
			6			8			
ocpement	c	o	m	p	e	t	e		
		7							
			10						

Hidden words	1	2	3	4	5	6	7	8	9	10	11	12
	-	-	-	<u>M</u>	-	-	-	-	-	-	<u>E</u>	-

### New Words:

**all over:** everywhere

**unite :** join together

(His aim was to unite the country)

**national:** connected with a particular nation;shared by a whole nation.

(The national anthems of the winning countries were played in the stadium.)

**hero :** a person who is admired by many people for doing something brave or good.

(Those who fight for their country are national heroes.)

## The Olympic Games

Every four years people all over the world watch the Olympic Games. It is a time for all kinds of people to unite in peace. Some of them join together to compete for gold medals. Millions of other people watch them on television.

Why do we have Olympic Games? How did they begin ?

The first Olympic Games were in Greece in 776 BC. There was only one event - people ran a race the length of the stadium. The Games lasted one day.

Slowly people added more events. The Games were only for men, and women could not even watch them. Only Greeks competed. They came from all parts of the Greek world. The time of the Games was a time of peace, and the government let everyone travel safely. Kings competed against common people. The winners became national heroes. The first modern games were in 1896, in Athens. The Greeks built a new stadium for the competition. Athletes from several countries competed. Then there were Olympics every four years in different cities in Europe and the United States until 1952. After that they were in Melbourne, Tokyo, Mexico City, and Montreal besides in European cities. Each year there were athletes from more nations. The first Winter Olympics were in 1924. The athletes compete in skiing and other winter sports.

Today there must be Olympic Games every four years. The Games must have at least fifteen events, and they cannot last more than sixteen days. There is no age limits—people of any age can compete.



a gold medal

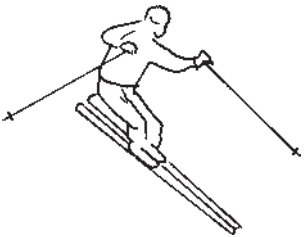

skiing

The competitors must not be professionals. They must be amateurs. The athletes compete for gold medals. The winners are still national heroes, as they were in the early Olympic Games in Greece.

## UNDERSTANDING

**PART A:** Which of the following sentences are true and which are false? Write “T” for true and “F” for false.

- \_\_\_\_\_ 1. In the past, the games lasted more than sixteen day.
- \_\_\_\_\_ 2. The first Olympic competitors ran the length of the stadium.
- \_\_\_\_\_ 3. The Winter Olympic also started in Greece in 776 BC.
- \_\_\_\_\_ 4. Little by little, more countries joined the games.
- \_\_\_\_\_ 5. Only Greeks could compete in the modern games.
- \_\_\_\_\_ 6. The word “it” in line two refers to the world.

**PART B:** Choose the best answer !

- 1. The Olympic Games help all kinds of people to \_\_\_\_\_.
  - a. compete for gold medals
  - b. watch the games
  - c. become national heroes
  - d. unite in peace
- 2. The Olympic Games were held in other cities such as Tokyo and Mexico City \_\_\_\_\_.
  - a. in 1896
  - b. after 1952
  - c. in 1924
  - d. every 4 years
- 3. “There is no age limit”. This statement means that \_\_\_\_\_ can compete in the games.
  - a. only young people
  - b. people of any race
  - c. both men and women
  - d. athletes of any age
- 4. The games must have at least \_\_\_\_\_.
  - a. 15 nations
  - b. 15 events
  - c. 16 winners
  - d. 16 days
- 5. After the Greeks built a new stadium, \_\_\_\_\_ from some other countries joined the competitions.
  - a. running
  - b. an event
  - c. athletes
  - d. skiing

**PART C:** Use the halves in column B to complete the sentences in column A!

- | <u>          A          </u>         | <u>          B          </u> |
|--------------------------------------|------------------------------|
| 1. The first Olympic Games .....( )  | a. were in 1924              |
| 2. The first modern games .....( )   | b. lasted one day            |
| 3. The first Winter Games ..... ( )  | c. were in 1896              |
| 4. The first Olympic Games ..... ( ) | d. until 1952                |
|                                      | e. were in Greece            |

**VOCABULARY**

**PART A:** Use the words in column B closest in meaning with the words in column A!

- | <u>          A          </u> | <u>          B          </u> |
|------------------------------|------------------------------|
| 1. last ( )                  | a. try to win                |
| 2. kinds ( )                 | b. ordinary                  |
| 3. compete ( )               | c. continue                  |
| 4. common ( )                | d. countries                 |
| 5. nations' ( )              | e. types                     |

**PART B:** Find the antonyms of the words. Write a, b, c, .....etc, in the spaces provided!

- | <u>          A          </u> | <u>          B          </u> |
|------------------------------|------------------------------|
| 1. peace ( )                 | a. fast                      |
| 2. slowly ( )                | b. ancient, old              |
| 3. winner ( )                | c. same, similar             |
| 4. modern ( )                | d. war                       |
| 5. different ( )             | e. last                      |
| 6. first ( )                 | f. loser                     |
| 7. professional ( )          | g. amateur                   |

**PART C:** Study the words in the following box. Use the word or phrase closest in meaning with the word or phrase underlined. Write your choices in the spaces provided.

countries    friendship    included    get together    everywhere

1. People **all over** the world (\_\_\_\_\_)

2. Slowly people **added** more events. (\_\_\_\_\_)
3. The time of the Games was a time of **peace**. (\_\_\_\_\_)
4. Each year there were athletes from more **nations**. (\_\_\_\_\_)
5. It is a time for all kinds of people to **unite** in peace.(\_\_\_\_\_)

**PART D:** Add an appropriate suffix to each of the following words.  
You can use suffixes given in the box.

-ion	-ation	-ition	-al
-ful	-d/-ed	itor	-or

- |                        |                     |
|------------------------|---------------------|
| 1. nation (      )     | 2. beauty (      )  |
| 3. compete (      )    | 4. peace (      )   |
| 5. unite (      )      | 6. limit (      )   |
| 7. profession (      ) | 8. compete (      ) |

**PART E:** Study the following examples

Example 1	Iran	→	Iranian
	Japan	→	Japanese

Example 2	England	→	English
	Greece	→	Greek
	Iraq	→	Iraqi

- | Country (noun) | people/language (adj/noun) |
|----------------|----------------------------|
| 1. _____       | Egyptian                   |
| 2. Germany     | _____                      |
| 3. Lebanon     | _____                      |
| 4. _____       | Spaniard /Spanish          |
| 5. _____       | Turkish                    |
| 6. America     | _____                      |
| 7. Greece      | _____                      |
| 8. India       | _____                      |
| 9. China       | _____                      |
| 10. _____      | French                     |

**PART F:** Unscramble the words in the parentheses and use them in the corresponding sentences! Finally, use the numbered letters to discover the hidden word.

1. (p u l f c e a e) Millions of people watch the \_\_\_\_\_ 1 \_\_\_ games on TV.

2. (n a l a t i o n) The winners became 2 \_\_\_\_\_ heroes.

3. (p o m c t i s e t i o n) The Greeks built a new stadium for \_\_\_\_\_ 3 \_\_\_\_\_.

4. (p o f a l i s e r n s) Are the competitors 4 \_\_\_\_\_?

Now put the numbered letters in the given order to find out the hidden word.

1 2 3 4      play



# LESSON TEN

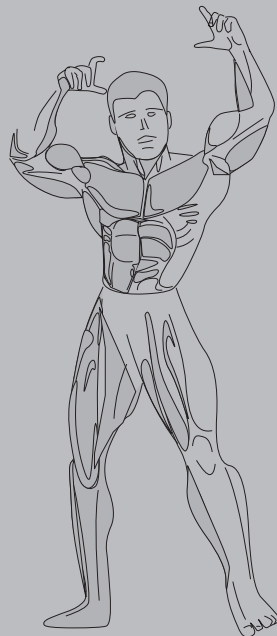

# LESSON TEN

## PHYSICAL EDUCATION

### New Words:

**objective:** something that you are trying to achieve; goal.  
(You must set realistic goals and objectives for yourself.)

**mission:** particular work that you feel it is your duty to do.  
(The mission for physical education is to make the body and mind healthy.)

**environment:** the conditions that affect the behavior and development of somebody or something.  
(An unhappy home environment can affect a child's behavior.)

**sportsmanship:** fair, generous and polite behavior especially when playing a game.  
(He is famous for skillful play and good sportsmanship.)

**expose:** (expose somebody to something) to let somebody find out about something by giving him experience of it or showing him what it is like.  
( We want the kids to be exposed to as much art and culture as possible.)

**recreation:** doing things for enjoyment, when you are not working.  
( You need some recreation after a hard day.)

### Dialogue: Goals

Instructor : Hello, class.

Students : Hello, sir .

Instructor : Today we are going to review some points in a physical education program .

Students : OK, sir.

Instructor : First , what is the main objective of a physical

education schools like our school .

Ebrahim : I think the main mission of any school is to provide educational excellence.

Instructor : How ?

Ebrahim : By providing a positive school environment.

Instructor : Fine . Now , Babak , what are the other goals ?

Babak : Well, they are also designed to teach skills , knowledge, sportsmanship and safety .

Instructor : Exactly. Morad , please tell us how such schools can reach these goals ?

Morad : Through being exposed to a wide variety of sports and recreational activities.

Instructor : Very good . OK class let's complete what we've discussed .

Students : OK, sir .



## UNDERSTANDING

**PART A :** Use the words or phrases in column B that are closest in meaning with the words in column A. Write a,b,c,..etc. in the parentheses provided !

A	
1. goal	( )
2. mission	( )
3. provide	( )
4. positive	( )
5. design	( )

B	
a. get to	
b. think of and plan	
c. objective	
d. make better	
e. duty ,task	
f. give, lend or supply	

**PART B :** Use the words in the box to complete the sentences that follow!

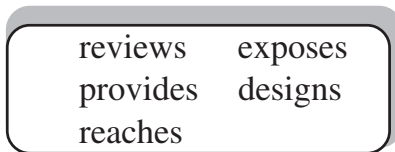

1. When a teacher goes over a lesson, s/he \_\_\_\_\_ the lesson .

2. When someone \_\_\_\_\_ you with something, s/he gives, lends, or supplies it .
3. When a person \_\_\_\_\_ a program ,s/he plans it for a particular purpose.
4. When your school \_\_\_\_\_ the students to a variety of sports, they let the students try, and enjoy those activities .
5. When your student succeeds , s/he \_\_\_\_\_ his/her goal .

### **New Words:**

**appreciate:** to recognize the good qualities of something.

(His family doesn't appreciate him.)

**organize:** to arrange something into a particular order or structure

(Computers organize a lot of data in a very short time)

**safety:** being protected from danger or harm.

(This is a place where children can play in safety.)

## **Physical Education Goals ( 1 )**

Every physical education school is expected to have a well organized program. Such programs are designed to teach skills, knowledge, sportsmanship, and safety through an exposure to a wide variety of sports and recreational activities . The students will establish a degree of physical fitness, respect for a healthy body and mind, and appreciation for lifetime sports.

## **UNDERSTANDING**

**PART A :** Which of the following sentences are false and which are True ? Write "T" or "F" before the sentence!

- \_\_\_\_\_ 1. In line 2 the phrase 'such programs' refers to life time sports.
- \_\_\_\_\_ 2. A well organized program is a good program.
- \_\_\_\_\_ 3. From the passage we understand that any well organized program is supposed to help the students in a limited way.

- \_\_\_\_\_4. Physical education concerns only recreational activities .
- \_\_\_\_\_5. Physical fitness results from the student's exposure to a variety of sports .

**PART B:** For each of the following definitions choose the most suitable word.

There are two extra words.

- |  |                      |
|--|----------------------|
| 1. sportsmanlike quality or spirit       | ( ) a. recreation    |
| 2. well and able to resist disease       | ( ) b. build         |
| 3. not being dangerous or in danger      | ( ) c. appreciate    |
| 4. way of spending free time, relaxation | ( ) d. safety        |
| 5. to understand and enjoy something     | ( ) e. sportsmanship |
|  | f. healthy           |
|  | g. degree            |

**PART C :** Organize the following groups of words into correct sentences !

1. body / mind / will / healthy / the students/ a / respect /and/ for.
1. \_\_\_\_\_
2. well / program/ was / that / organized /very ?
- 2 \_\_\_\_\_?

**PART D:** Write the Farsi word for each of the following !

- |                          |                                |
|--------------------------|--------------------------------|
| 1. lifetime sports _____ | 5.recreational activities_____ |
| 2. sportsmanship _____   | 6. degree _____                |
| 3. respect _____         | 7. is expected _____           |
| 4. establish _____       | 8. knowledge _____             |

**New Words:**

**advantage:** a quality of something that makes it better or more useful.

**adult:** a fully grown person who is responsible for his/her actions.

**adulthood:** being an adult.

**cancer:** a serious disease in which cells of the body grow in an abnormal way.

**hypertension:** blood pressure that is higher than is normal.

**coronary:** connected with the heart, particularly the arteries that take blood to the heart.

## Physical Education Goals ( 2 )

The overall mission of the physical educator is to help all students enjoy and learn physical activities so that they will continue to be active for the rest of their lives. The following offers a short list of the advantages a physical education program can offer : They

- \*prepare students with skills for future by exposing them to various individual and team activities.
- \*formulate activity patterns that can be extended into adulthood.
- \*reduce risk for specific health problems including: coronary heart diseases, hypertension, colon cancer, and depression , as well as lower all-cause death rates.
- \*improve understanding of health-related fitness concepts .
- \*develop students' sense of security with their own body.
- \*improve overall mental health .
- \*reduce stress and increase energy-enriching quality of life.
- \*teach safety techniques, reducing accidents outside of school.
- \*increase awareness of physical opportunities within the family and the community.

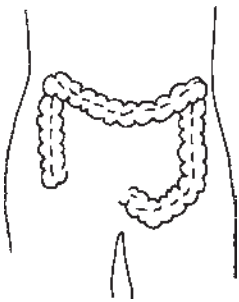

colon

## UNDERSTANDING

**PART A :** Some of the sentences are false and some are true. Write “T” or “F” before each of the sentences.

- \_\_\_\_\_ 1. The physical education program can help us in many ways.
- \_\_\_\_\_ 2. Learning and enjoying the physical activities are the only things such programs can give us.
- \_\_\_\_\_ 3. Colon cancer is a health problem.
- \_\_\_\_\_ 4. Some activity patterns are also suitable for other stages of life.

**PART B:** Underline the most suitable word or phrase!

1. A good physical education program helps you ( reduce/ increase ) health problems.
2. Such programs expose the students to individual ( or / and ) team activities.
3. Another advantage of a physical education program is that they help us improve our overall mental (problem / health ).
4. If you follow such programs, you will continue to be active ( for the / to ) rest of your life.

**PART C :** Choose the best answer !

1. In line two “ they” refers to \_\_\_\_\_.  
a. advantages  
b. physical education  
c. physical educator  
d. the students
2. In line five ‘various’ means \_\_\_\_\_ .  
a. short  
b. different  
c. specific  
d. similar
3. One way to \_\_\_\_\_ is to take part in a physical education program.  
a. increase risk for specific health problem  
b. reduce energy enriching quality of life  
c. live a happy and healthy life.  
d. Improve all-cause death rates .

4. If you follow a well-organized physical education program, you can improve your \_\_\_\_\_ .
- a. overall mental health
  - b. accidents outside of school
  - c. safety techniques
  - d. sense of security with your own body
5. Which is NOT one of the advantages of the physical education program ?
- a. Teaching skills
  - b. Improving one's sense of security
  - c. Depression
  - d. Reducing risk for specific health problem

## **FURTHER ACTIVITIES**

### **I - FREE READING :**

#### **Definition of a Physically Educated Person**

A physically educated person is a lucky person for many reasons. However , in this short paragraph ,we are going to learn about a few of them. First, s/he has learned the skills necessary to perform a variety of physical activities. Second, s/he knows the implications of and the benefits from the involvement in physical activities. The third reason concerns his or her being physically fit . Next, a physically educated person knows the rules ,strategies and appreciates behaviors for selected physical activities. Finally , a physically educated person respects the role that regular physical activity plays in pursuit of lifelong health and well being.

### **II- TRANSLATION**

#### **Translate the following into Farsi**

A physically educated person recognizes that participation in physical activities can lead to multicultural and international understanding. Such a person appreciates the relationship with others that results from participation in physical activities.



## List of References

### I. BOOKS

Mood, Dale, Frank F. Musker and Judith E. Rink, *Sports and Recreational Activities for Men and Women*, Tenth Edition, Mosby Yearbook Inc., Missouri, 1991.

*The Athletics Track and Field Coaching Manual*, The Athletics Congress's Development Committees with Vern Gambetta, Editor, Second Edition, Leisure Press, Illinois, 1989.

David G. Thomas, *Advanced Swimming, Steps to Success*. Leisure Press, Illinois, 1990.

Larry Hodges, *Table Tennis, Steps to success*, Leisure Press, Illinois, 1993. Scaun, Ruth et al, *Readings II (Book 2)*. American Language Institute of New York University , 1971.

### II. DICTIONARIES

*The Concise Oxford Dictionary*, Seventh Edition. Oxford University Press, 1982.

*BBC English Dictionary*, Harper Collins Publishers, London, 1993.

*The American Heritage School Dictionary*, American Heritage Publishing Co. Inc. New York, 1972.

*Webster's Sport Dictionary*, G.&C. Merriam Company Publishers USA.

### III. WEB SITES

Different web sites including, [encyclopedia.com](http://encyclopedia.com), [encarta.com](http://encarta.com) and [burtrandworld.com](http://burtrandworld.com).

# Appendix I

## List Of Abbreviations

- (F.I.B.A) Federation International de Basketball Amateur(French)  
International Federation of Amateur Basketball(English)
- (F.I.F.A) Federation International de Football Association  
(French)  
International Football Association Federation (English)
- (F.I.L.A) Federation International de Lutter Amateur (French)  
International Federation of Amateur Wrestling (English)
- (F.I.N.A) Federation International de Natation Amateur (French)  
International Amateur Swimming Federation (English)
- (F.I.V.B) Federation International de Volleyball (French)  
International Federation of Volleyball (English)
- (I.A.A.F) International Amateur Athletic Federation
- (I.B.F) International Badminton Federation
- (I.C.S.P.E) International Council of Sport and Physical Education
- (I.H.F) International Handball Federation
- (I.T.T.F) International Table Tennis Federation

# Appendix II

## List of New Words

- adult:**(n), a fully grown person who is responsible for his/her actions.  
(lesson ten)
- adulthood:**(n), being an adult. (lesson ten)
- advantage:**(n), a quality of something that makes it better or more  
useful. (lesson ten)
- afloat:** floating on water. (lesson four)
- all over:**(adv), everywhere. (lesson nine)
- amateur :**(n), a person who takes part in sports or other activities for  
enjoyment or interest, not as a job. (lesson nine)
- appreciate:**(v), to recognize the good qualities of something.(lesson ten)
- athletic:**(adj), relating to sports. (lesson six)

**award:**(v), to make decision to give something to somebody as a prize.  
(lesson six)

**basic:**(adj), most necessary or important. (lesson six)

**boost:**(v), increase the value or amount of something. (lesson three)

**boycott :**(v), to refuse to buy, use or take part in something.(lesson nine)

**breath:**(v),take in and let out air through your nose and mouth. (lesson one)

**burn up:**(v), use energy by doing exercises. (lesson one)

**cancer:**(n), a serious disease in which cells of the body grow in an abnormal way. (lesson ten)

**cardiovascular:**(adj), relating to the heart and blood vessels. (lesson six)

**circulate:**(v), move in a closed path. (lesson one)

**commit:** (v), to do (something wrong or illegal). (lesson six)

**competition:**(n), a game that people try to win; a contest. (lesson four)

**competitor:** a person who takes part in a competition. (lesson three)

**contact:**(n), the act of touching something. (lesson seven)

**contest:**(n), struggle, competition, fight. (lesson two)

**coordination:**(n), the act of making things work together. (lesson three)

**coronary:**(adj), connected with the heart, particularly the arteries that take blood to the heart. (lesson ten)

**defend:** (v), to keep safe from harm. (lesson six)

**defender:**(n), a player who must stop the other team from scoring a goal. (lesson six)

**defense:**(n),(also spelled defence), the act of attempting to protect one's side form an opponent's attack. (lesson eight)

**defensive:** (adj), used for defending; e. g. defensire tactics, a defensive position. (lesson six)

**depressed:**(adj), very sad; without hope. (lesson one)

**disappear:**(v), to stop existing; to vanish. (lesson four)

**disqualify:**(v), prevent somebody from doing something because they have broken a rule. (lesson two)

**distribute:**(v), to place at different points. (lesson two)

**don't mention it :** used as a polite answer when somebody has thanked you for something. (lesson eight)

**drag:**(v), move or make something move, partially touching the ground. (lesson three)

**dribble:**(v), to move or advance the ball along the ground with

successive light kicks. (lesson six)

**efficient:**(adj), doing something well and successfully. (lesson four)

**elementary school:**(n), a school for children between the ages of 6 and 12. (lesson six)

**endurance:**(n), the ability to continue doing something difficult for a long period of time. (lesson six)

**enthusiasm:**(n), interest or admiration for something. (lesson three)

**environment:**(n), the conditions that affect the behavior and development of somebody or something. (lesson ten)

**equipment:**(n), the things that are needed for a particular purpose. (lesson two)

**event:**(n), any of the individual contests that comprise a sports program. (lesson two)

**exceed:**(v), be greater than a particular number or amount. (lesson three)

**expose:**(v), (expose somebody to something) to let somebody find out about something by giving him experience of it or showing him what it is like. (lesson ten)

**fit:**(adj), in shape; healthy and strong. (lesson one)

**float:**(v), To stay on top of water. (lesson four)

**forward:**(adj), directed or moving towards the front. (lesson six)

**foul :**(n), against the rules of the game. (lesson eight)

**fundamental:**(adj), serious and very important.(lesson two)

**gliding:**(v), moving smoothly and quietly, without much effort.(lesson four)

**graceful:**(adj), moving in a smooth and beautiful way. (lesson four)

**guarding :**(n), attempting to prevent an opponent from playing effectively or from scoring. (lesson eight)

**gymnast:**(n), a person who performs gymnastics especially in competition.(lesson two)

**healthy:**(adj), well; not ill; how well your body is. (lesson one)

**hero :**(n), a person who is admired by many people for doing something brave or good. (lesson nine)

**hypertension:**(n), blood pressure that is higher than is normal.(lesson ten)

**improve:**(v), make or become better. (lesson one)

**indoor:**(adj),(n), done or used inside a building. (lesson five)

**infractions:**(n), an act of breaking of playing rules. (lesson six)

**injury:**(n), damage to the body of a player. (lesson seven)

**instinct:**(n), a natural tendency that makes people and animals do certain things. (lesson four)

**instinctive:**(adj), based on instinct. (lesson four)

**interfere:**(v), to get in the way of; prevent from working or happening.  
(lesson six)

**introductory activities:**(n), lead up activities. (lesson three)

**involve:**(v), to cause (someone or oneself) to be come connected or concerned in; to have as a necessary part or result.  
(lesson six)

**jump ball :**(n), a method of putting the ball in play that consists of the referee's tossing the ball. (lesson eight)

**kicking:**(n), driving a ball by hitting it with the foot. (lesson six)

**land:**(v), come onto the ground. (lesson three)

**lead up activities:**(n), preparatory activities; activities at the beginning of a task. (lesson three)

**line up :**(v), to get into form in a line; to take one's position in. (lesson eight)

**make a basket:**(v), (also shoot a basket) to gain a point by throwing the ball through the basket net. (lesson eight)

**make progress:**(n), become better. (lesson four)

**midcourt :**(n), the area of the basketball court just on either side of the division line. (lesson eight)

**mission:**(n), particular work that you feel it is your duty to do.(lesson ten)

**muscular:**(adj), of or relating to muscles. (lesson six)

**national :**(adj), connected with a particular nation; shared by a whole nation.(lesson nine)

**nervous:**(adj), worried or afraid. (lesson one)

**objective:**(n), something that you are trying to achieve; goal.(lesson ten)

**offense :**(n), the act of attacking an opponent or of attempting to score points in a contest. (lesson six)

**organize:**(v),to arrange something into a particular order or structure.  
(lesson ten)

**original:**(adj), first; earliest. (lesson seven)

**outstretched:**(adj), stretched or spread as far as possible. (lesson five)

**overlap:**(v), when two things overlap, part of one thing covers part of another thing. (lesson seven)

**overtime:**(n), an extension of the playing time to decide a winner.  
(lesson eight)

**participate:**(v),To take part in an activity.

**passing zone:**(n), (also exchange zone or take over zone) an area

marked in each lane of the track within which the exchange of the baton must take place in a relay race.  
(lesson two)

**peace:**(n), a period of time in which there is no war or violence in a country or an area. (lesson nine)

**penalize:**(v), to punish (a team or player). (lesson six)

**permission:**(n), allowing somebody to do something. (lesson seven)

**physical education:** lessons in school in which students do physical exercises or take part in physical activities or sports.  
(lesson two)

**points :**(n), the basic scoring unit in most games. (lesson eight)

**popular:**(adj), liked by many people. (lesson five)

**popularity:**(n), being liked by a lot of people. (lesson five)

**prohibition:**(n), a rule that stops something being done. (lesson six)

**rate of improvement:**(n), a measurement of the speed at which something becomes better. (lesson three)

**recreation:**(n), doing things for enjoyment, when you are not working.  
(lesson ten)

**recreation:**(n), a particular activity that people do for enjoyment , when they are not working. (lesson four)

**regain :**(v), to get back. (lesson eight)

**relaxing :**(adj), helping you to rest or become less anxious.(lesson one)

**remove:**(v), take somebody or something away or off. (lesson seven)

**replace:**(v), to be used instead of something or somebody else.; put a new or different person or thing in the place of another.  
(lesson seven)

**report:**(v), to give somebody information that you have done, heard or seen something. (lesson seven)

**resemble:**(v), look like; be similar to another person or thing.(lesson three)

**rotation:**(n), the action of players moving in a clockwise direction when regaining the serve. (lesson seven)

**run ups:**(n), a run made to gain speed for making a jump. (lesson three)

**safety:**(n), being protected from danger or harm. (lesson ten)

**sanction:**(n), a formal action or punishment ordered when alaw or rule is broken. (lesson six)

**score :**(v), to make a score in a game or contest. (lesson eight)

**score:** (n), the number of pornts, goals, etc. each player or team

gains.(lesson eight)

**scorer:**(n), someone who records the score of a game or contest as an official or under the direction of the chief official. (lesson seven)

**shifting:**(adj), moving from one position or place to another. (lesson seven)

**shot :**(n), the throwing or propelling of the ball toward the basket.(lesson eight)

**shot put:**(n), a field event in which a shot is thrown for distance. (lesson three)

**soccer:**(n), football. (lesson one)

**spectacular:**(adj), impressive; wonderful to see. (lesson three)

**sportsmanship:**(n), fair, generous and polite behavior especially when playing a game. (lesson ten)

**spot:**(n), a particular area or place. (lesson six)

**sprint starts:**(n), a position normally used by competitors at the start of sprint races. (lesson three)

**sprint:**(n), a short, fast race. (lesson two)

**sprinter:**(n), a person who takes part in a short, fast race. (lesson two)

**steplechase:**(n), a race on a track with some hurdles and a water jump. (lesson two)

**strike:**(v), hit. (lesson five)

**striking:**(v), hitting something or somebody; hitting or kicking a ball. (lesson six)

**substitution:**(n), the replacing of one or more players in the game by other players on the team. (lesson seven)

**teammate:**(≠opponent)(n), someone who plays on the same team as another. (lesson six)

**technique:**(n), a special way of doing something. (lesson four)

**tension:**(n), being worried because you are waiting for something. (lesson one)

**term:**(n), a word or expression, often used in relation to a particular subject. (lesson four)

**the triple jump:**(n), a sporting event in which people try to jump as far forward as possible with three jumps. (lesson three)

**throw-in:**(n), the act of throwing the ball back onto the playing field after it has gone outside the area. (lesson six)

**throwing circle:**(n), a circular area (7 feet in diameter)in which a

competitor must remain during his attempt. (lesson three)  
**tie**:(v), to make one's score equal to the opponent's score.(lesson eight)  
**track and field**:(n), sports that people compete in, such as running  
and jumping. (lesson two)  
**tremendous**:(adj), very great. (lesson three)  
**unite** :(v), join together. (lesson nine)  
**unscramble** :(v), to arrange something that is confused or in the wrong  
order in a clear, correct way. (lesson nine)  
**vaulting**:(also pole vaulting):(n), a field event in which each contestant  
uses a long pole to vault over a horizontal bar that  
rests between two upright standards. (lesson two)  
**vital**:(adj), very important; something that you must do or have.( lesson  
one)

