

* به پدر و مادر خود نیکی کنید.
قرآن کریم

بخش ۱

نگاره‌ها



سلام!
سلام!

کامل کن.

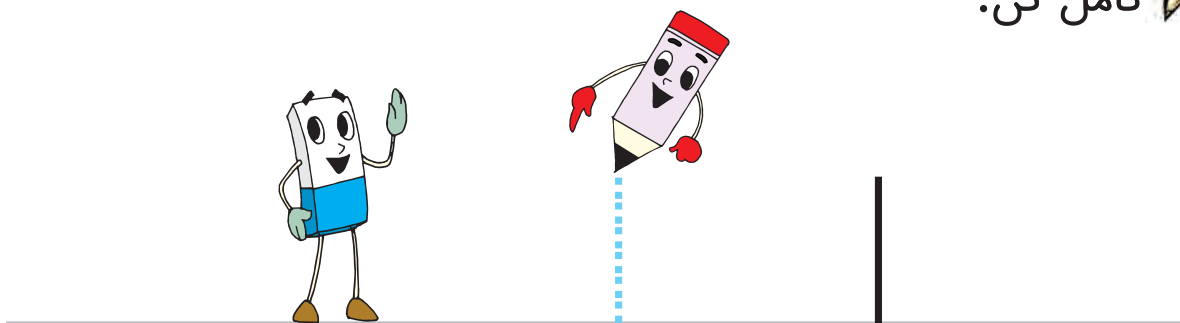

کامل کن و رنگ بزن.

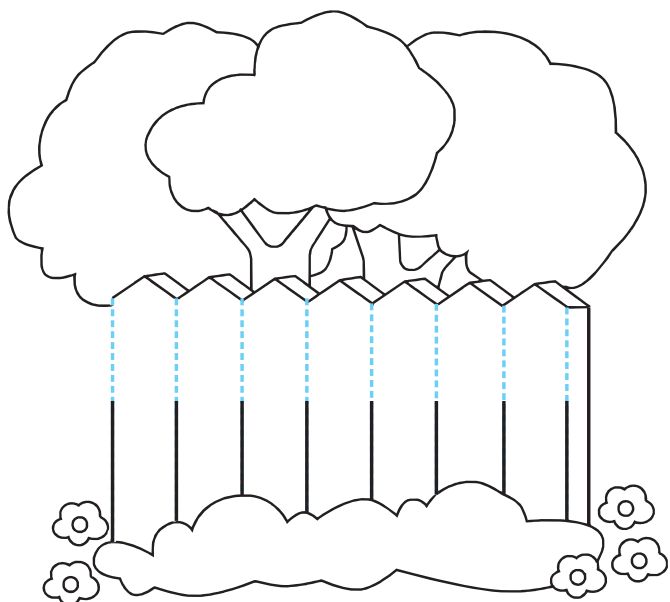

بنویس.

Four horizontal blue lines for writing. On the left side, there are four empty square boxes stacked vertically. To the right of the lines, there is a red vertical line with a downward-pointing arrow next to it, indicating the direction of writing.

آفرین!



کامل کن. 

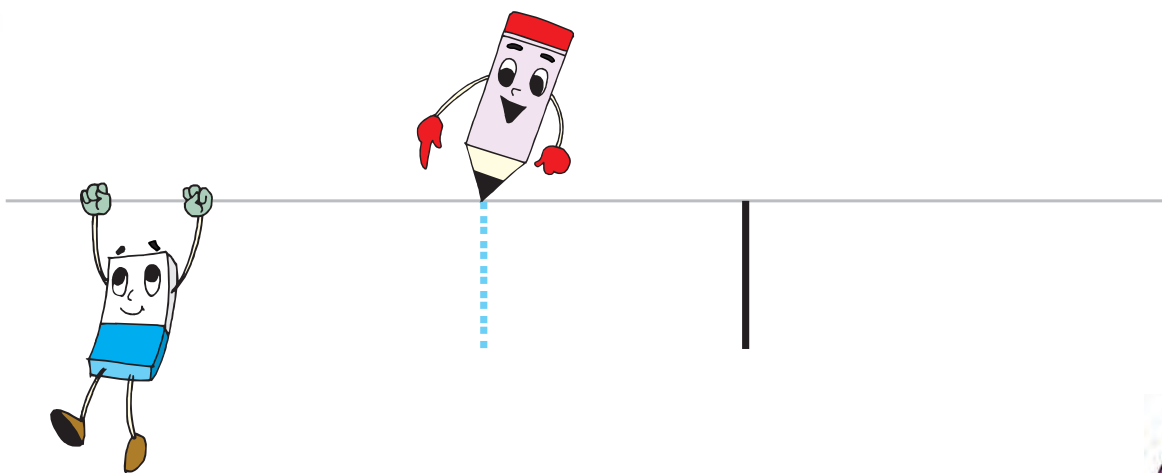

کامل کن و رنگ بزن. 

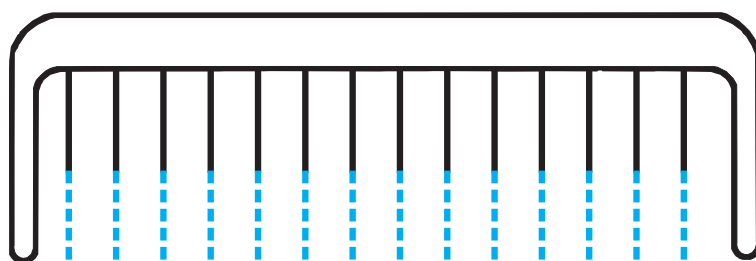

بنویس. 



سلام!

کامل کن.

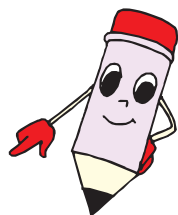
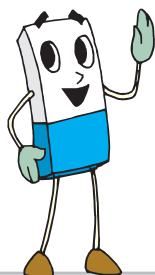

کامل کن و رنگ بزن.

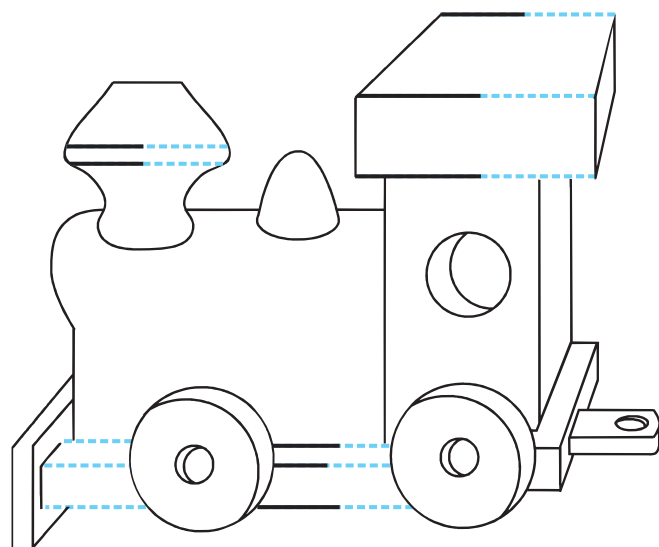

بنویس.



خسته نباشی!



کامل کن.

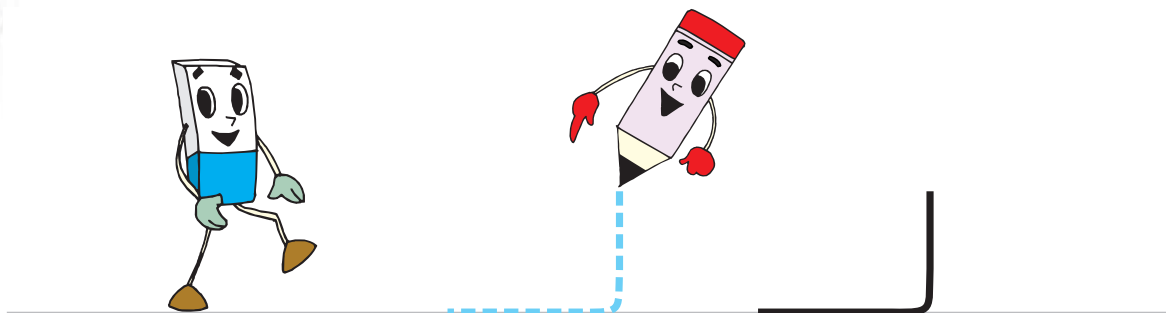

کامل کن و رنگ بزن.

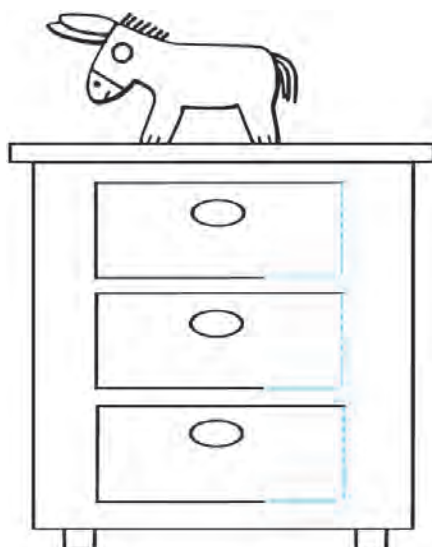

بنویس.



سلام
دوست من!

کامل کن.

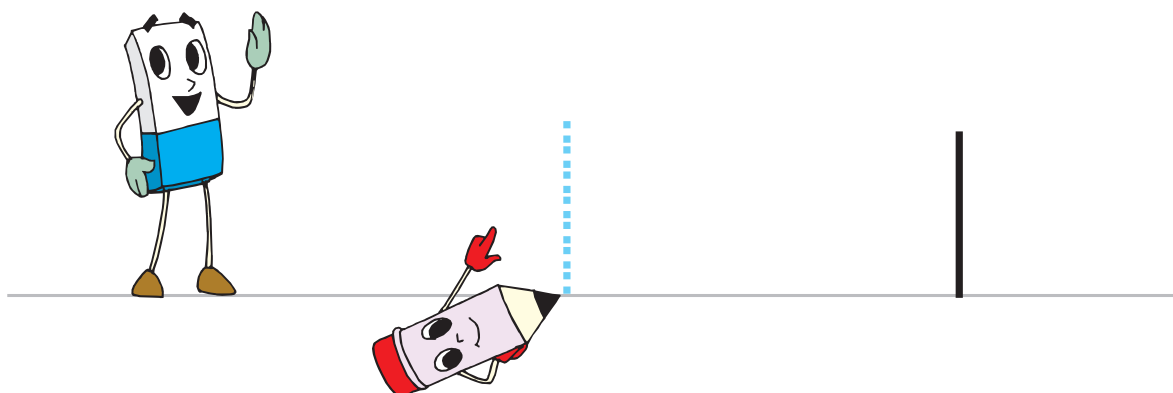

کامل کن و رنگ بزن.

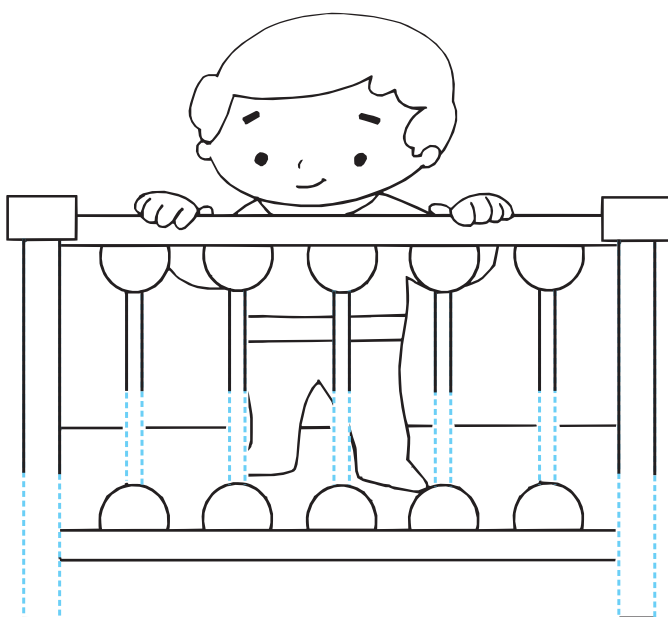

بنویس.

Four horizontal blue lines for writing. On the left side, there are four small empty square boxes stacked vertically. On the right side, there is a vertical red line with an upward-pointing arrow next to it.

دست
درد نکند!



کامل کن.

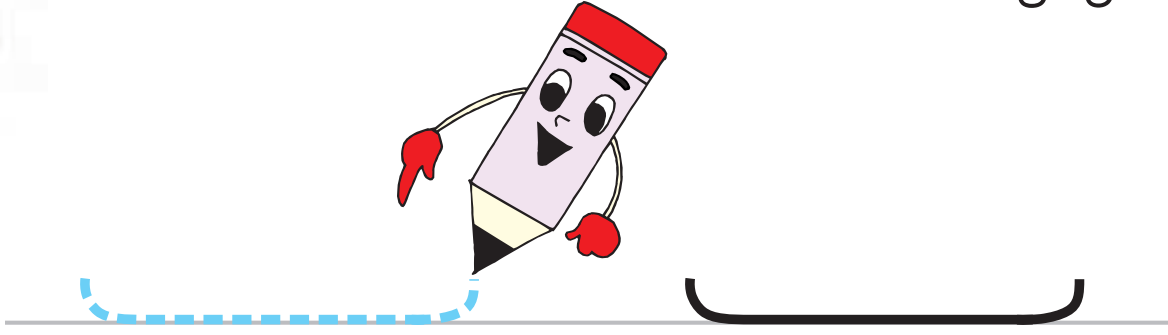

کامل کن و رنگ بزن.

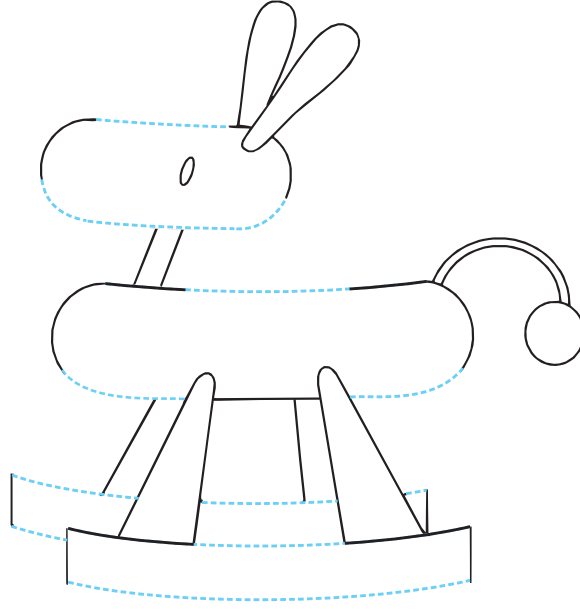

بنویس.

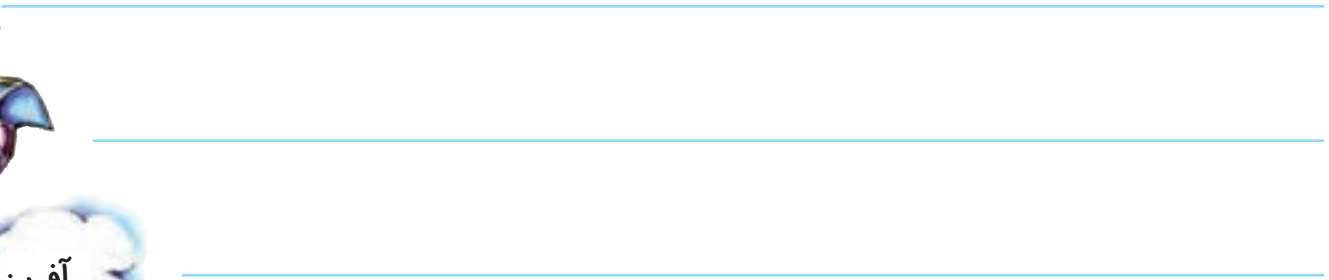

آفرین!

سلام،
روز به خیر!

کامل کن.

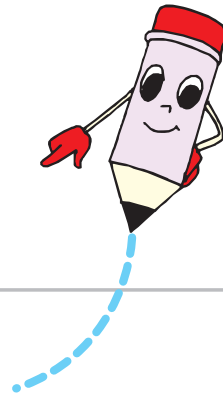
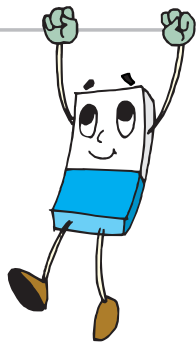

کامل کن و رنگ بزن.

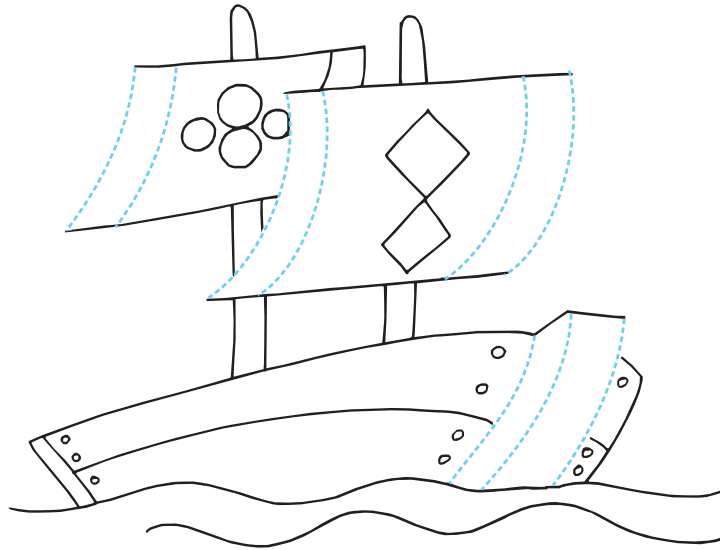

بنویس.



خسته نباشی!



کامل کن. 

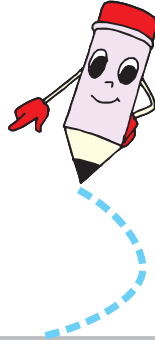

کامل کن و رنگ بزن. 

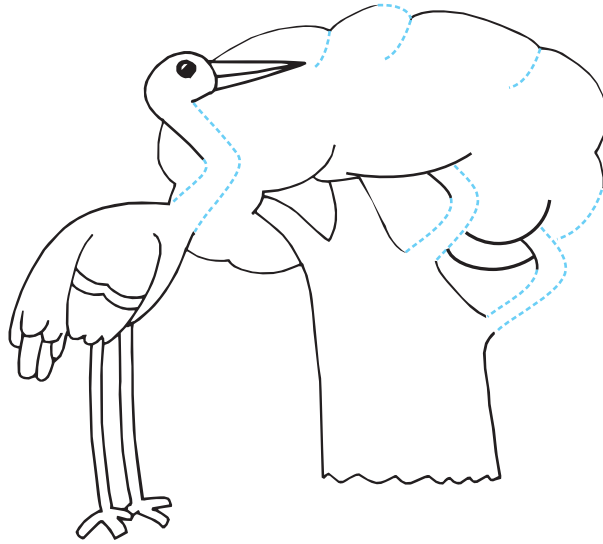

بنویس. 



خدا قوت!

سلام،
روز به خیر!

کامل کن.

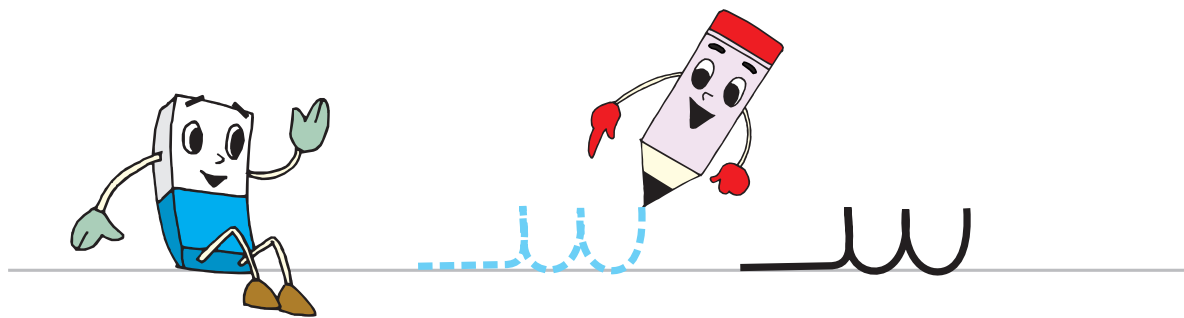

کامل کن و رنگ بزن.

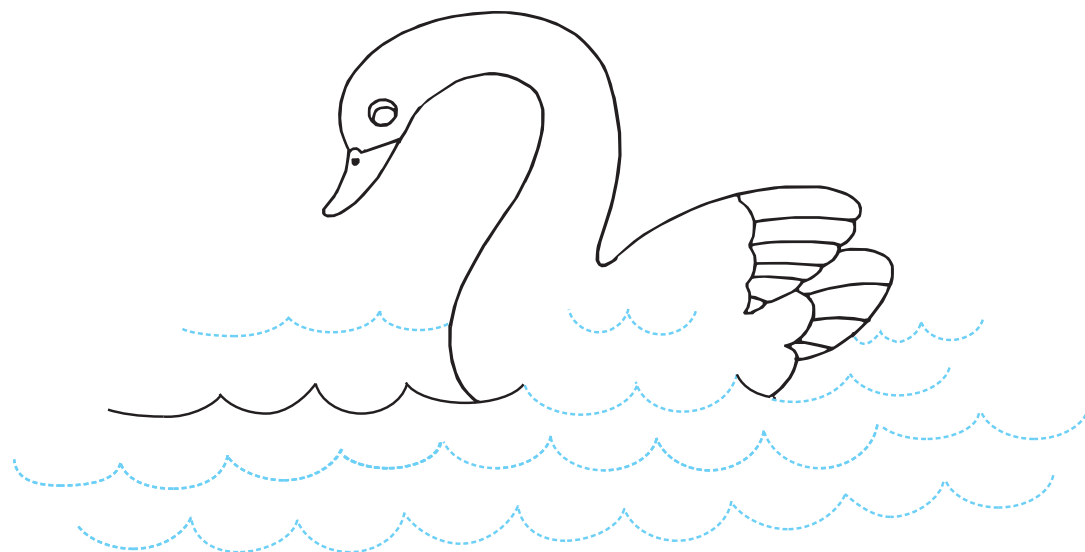

بنویس.



آفرین!



کامل کن.

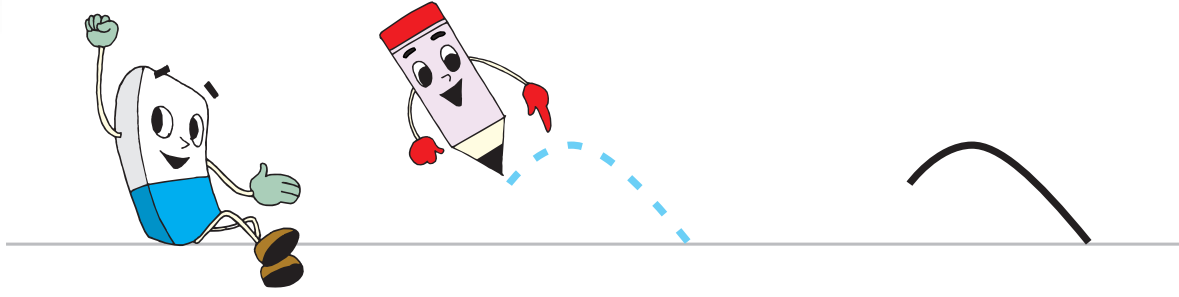

کامل کن و رنگ بزن.

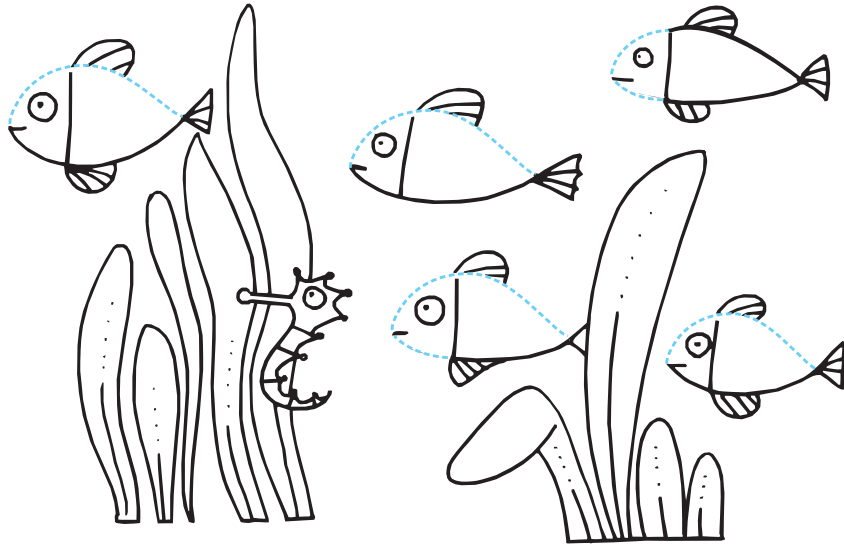

بنویس.

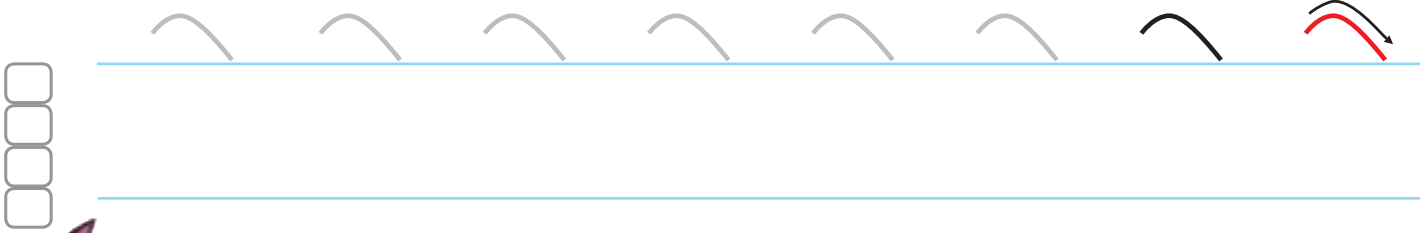

سلامت باشی!

سلام،
روز به خیر!

کامل کن.

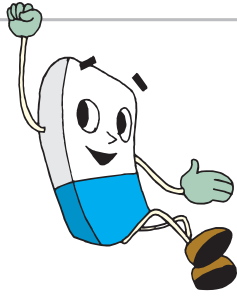
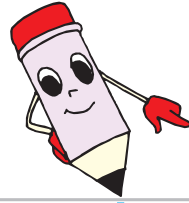

کامل کن و رنگ بزن.

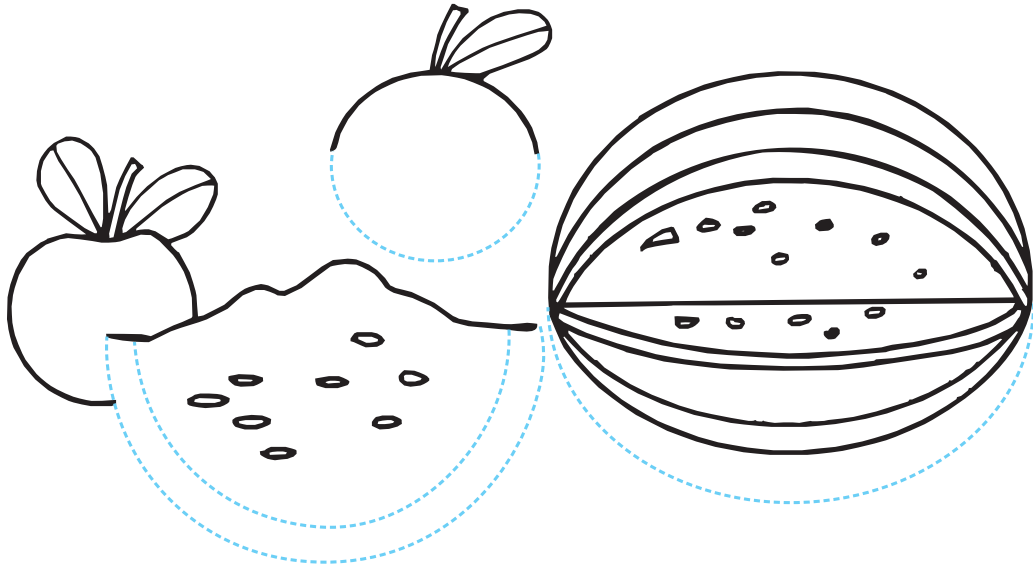

بنویس.



آفرین عزیزم!



کامل کن. 

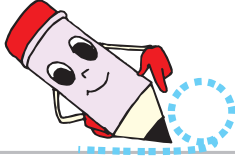
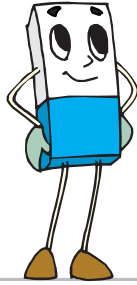

کامل کن و رنگ بزن. 

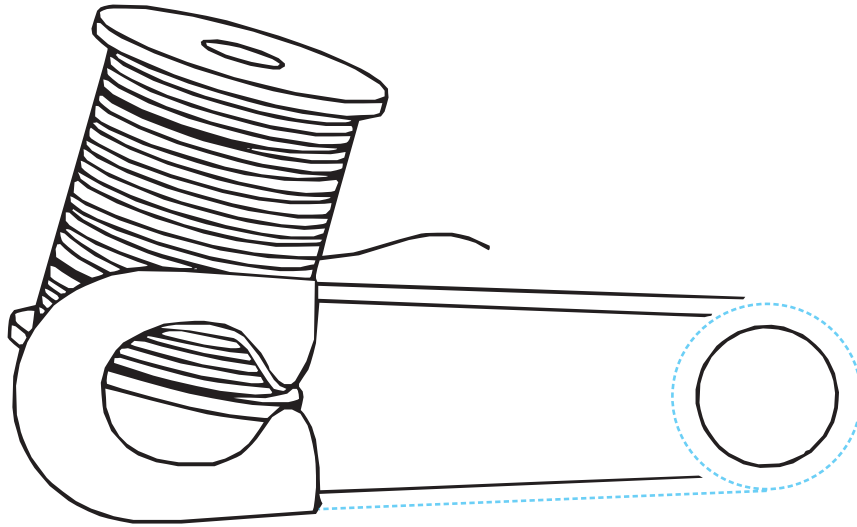

بنویس. 



روزت به خیر!

سلام
هم شاگردی!

کامل کن.

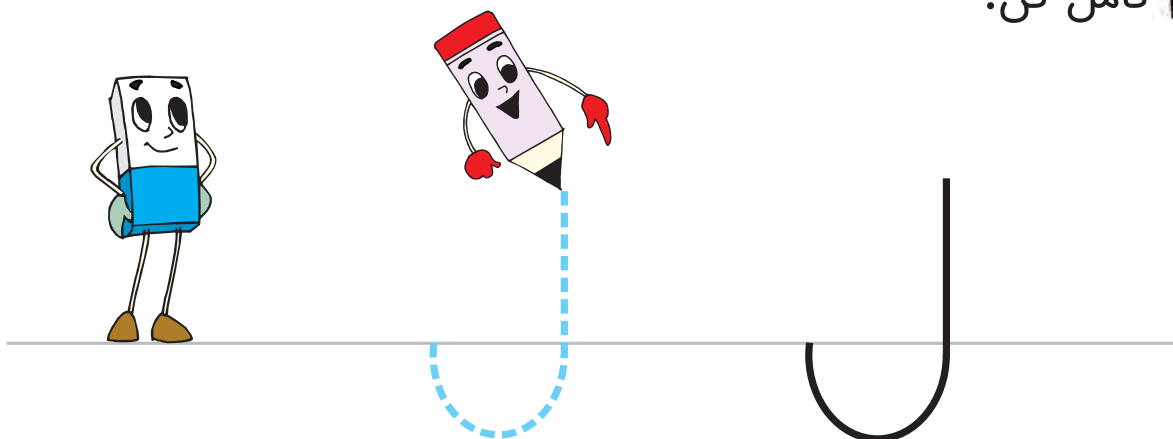

کامل کن و رنگ بزن.

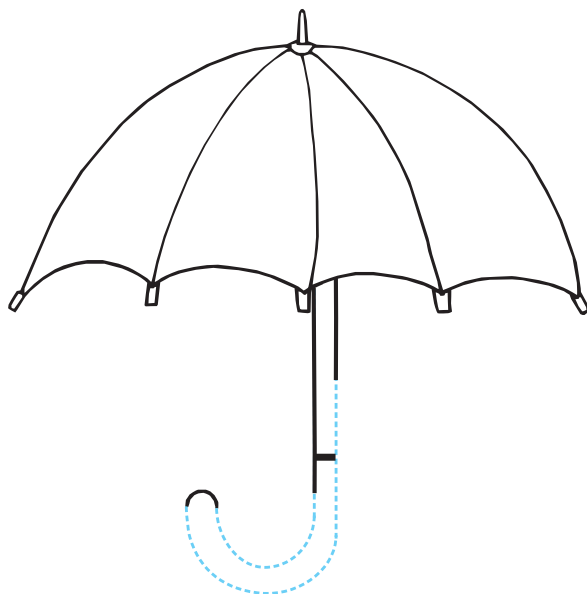

بنویس.

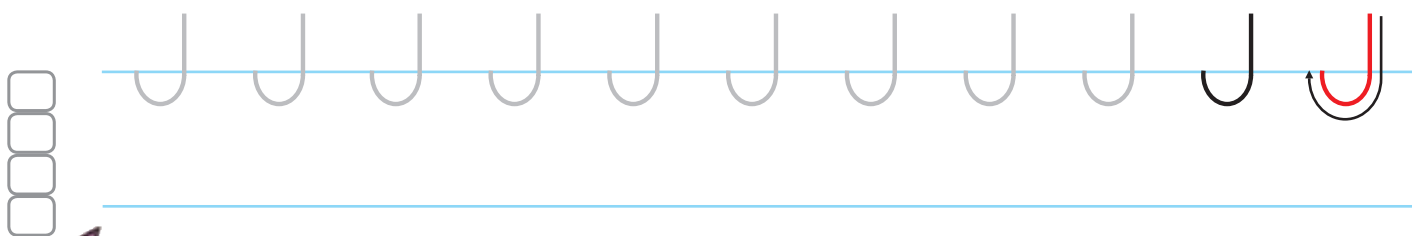



کامل کن.

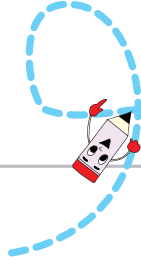
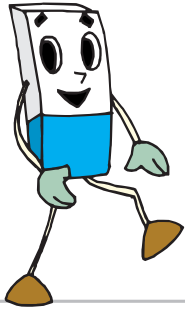

کامل کن و رنگ بزن.

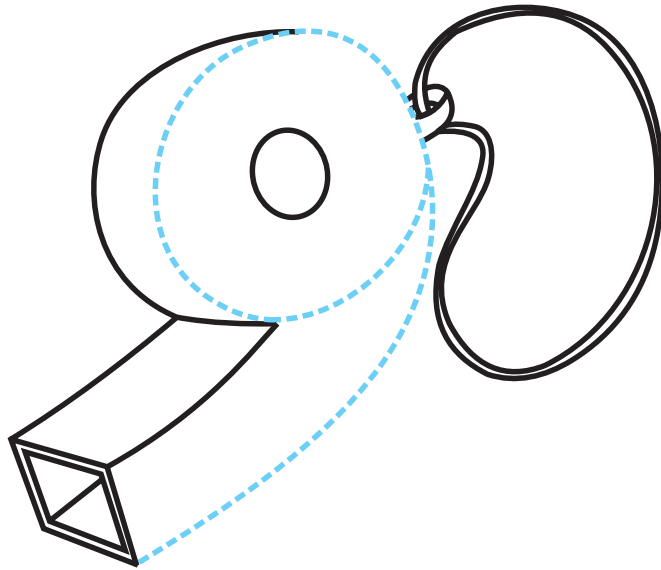

بنویس.

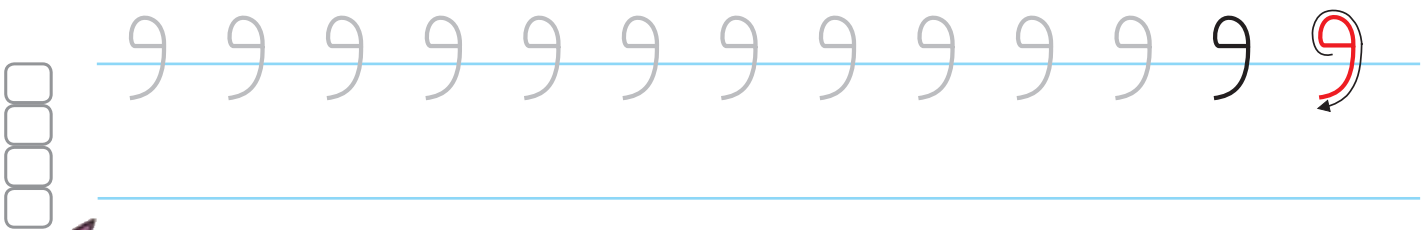

دوست من
سلام!

کامل کن.

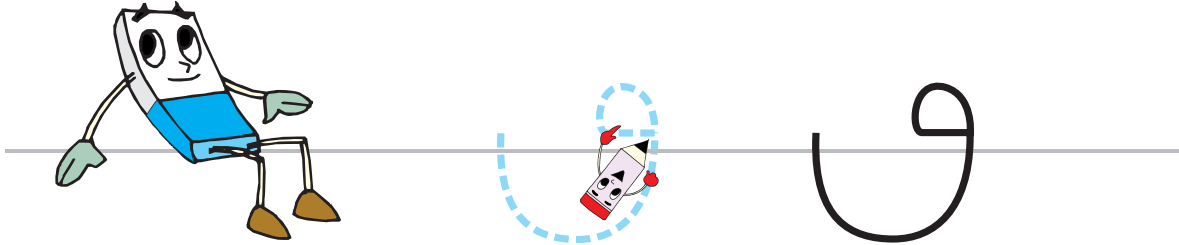

کامل کن و رنگ بزن.

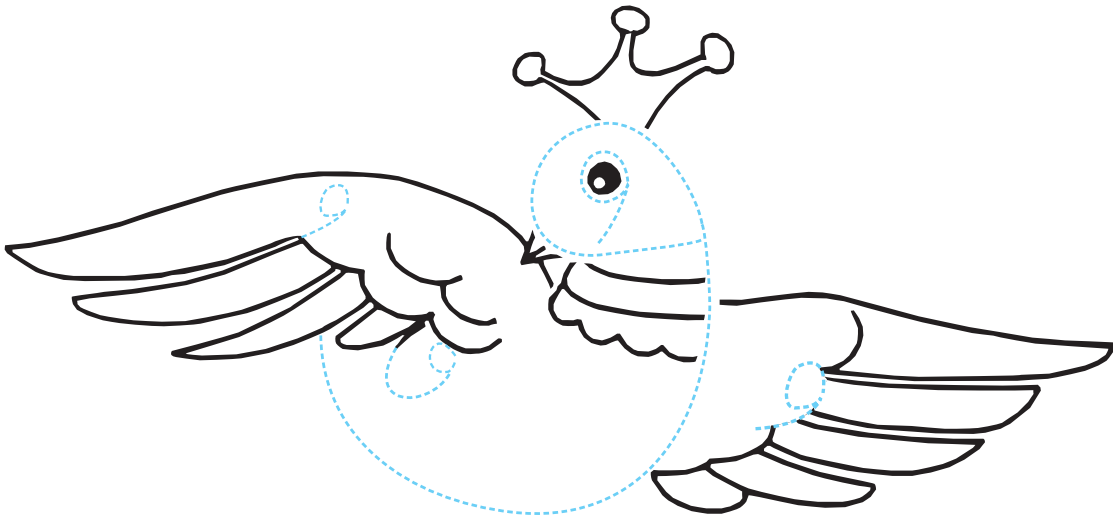

بنویس.



با هم مهربان
باشیم!



کامل کن.



کامل کن و رنگ بزن.

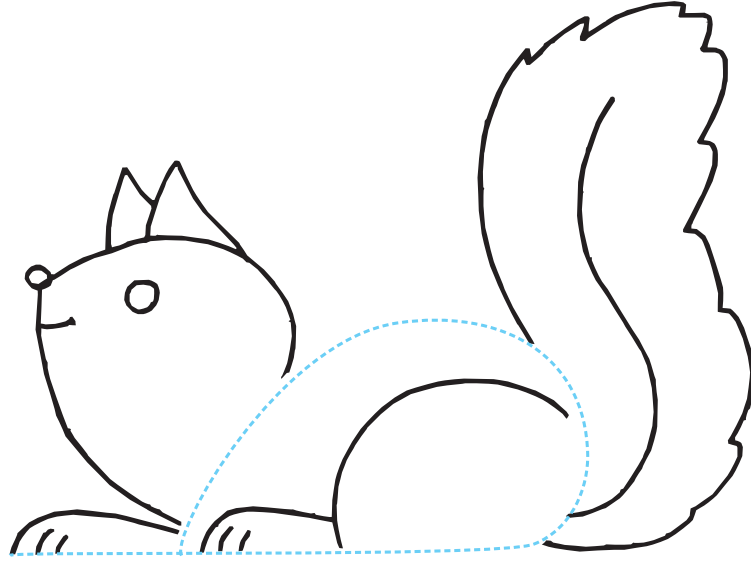

بنویس.



خوش
به حالت!

سلام!

کامل کن.

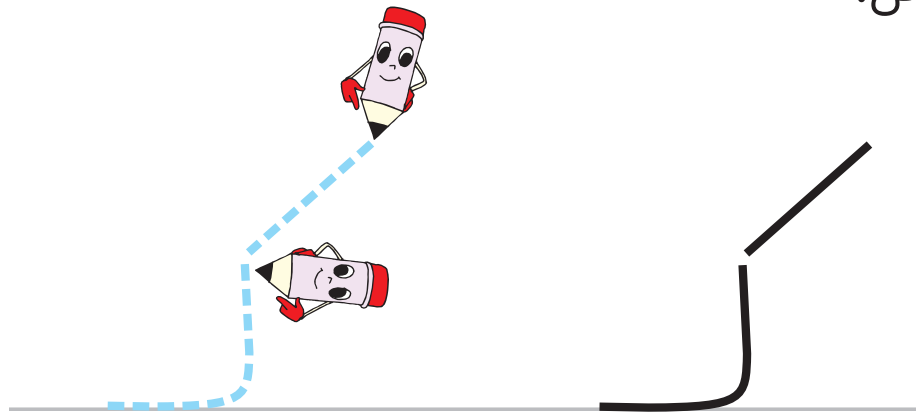

کامل کن و رنگ بزن.

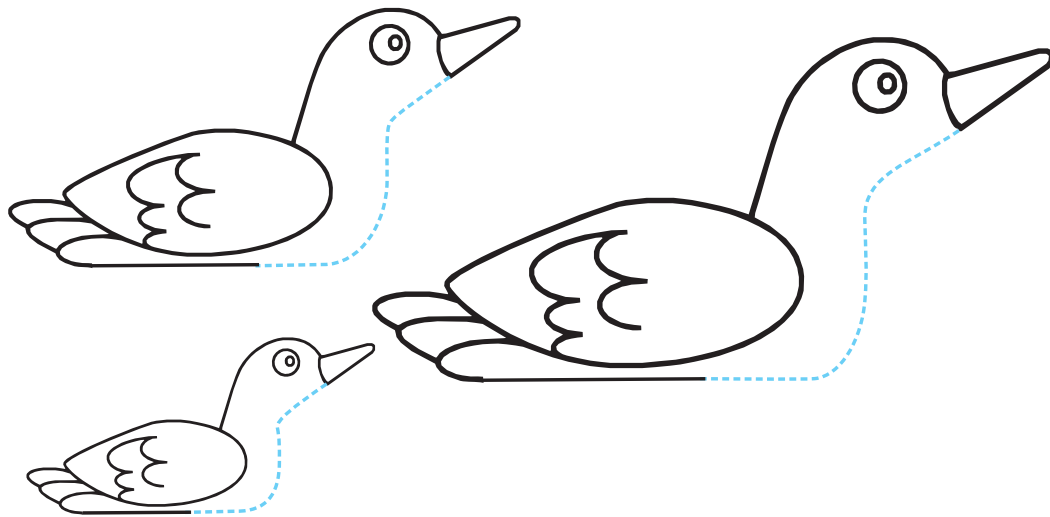

بنویس.

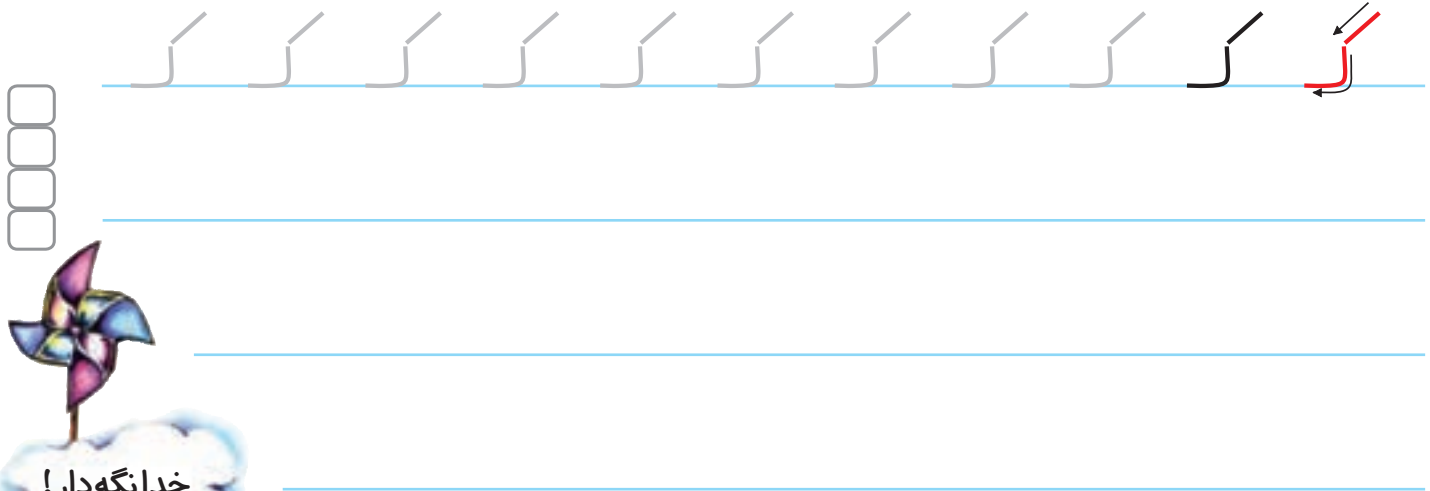

خدانگه دار!



کامل کن. 

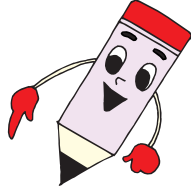
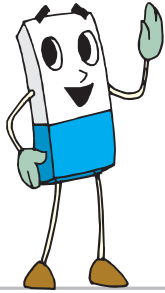

کامل کن و رنگ بزن. 

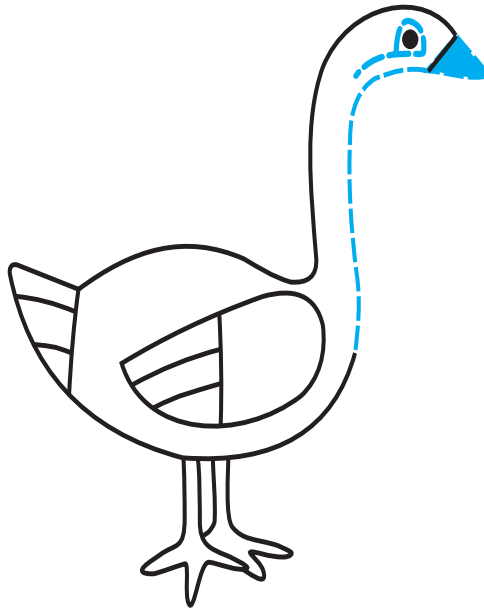

بنویس. 

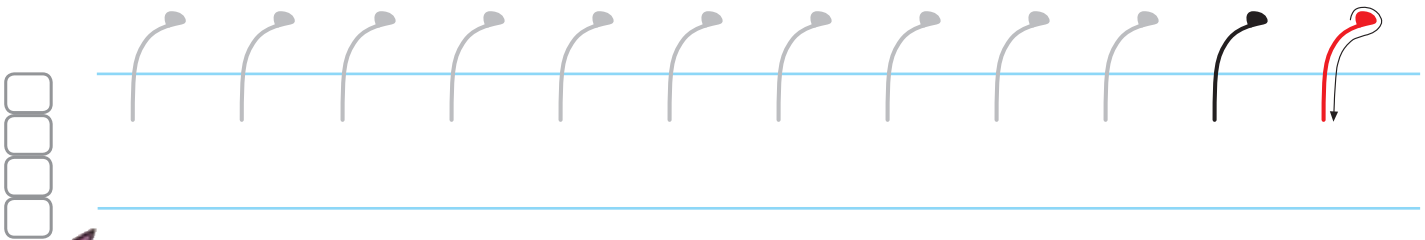

آفرین!

هم کلاسی
سلام!

کامل کن.

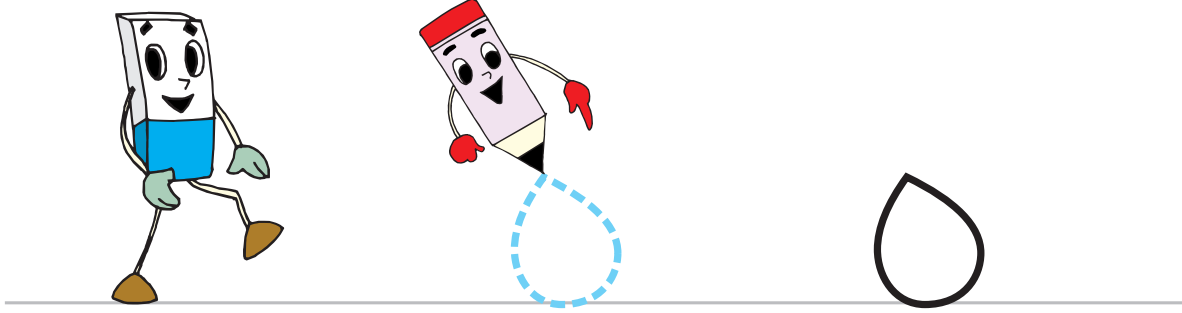

کامل کن و رنگ بزن.

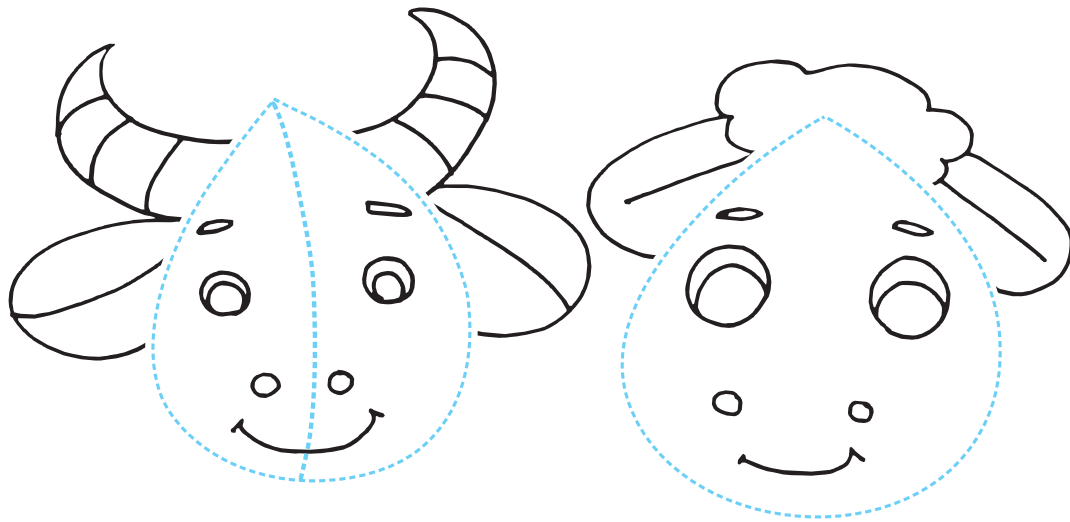

بنویس.



روز به خیر!



کامل کن. 

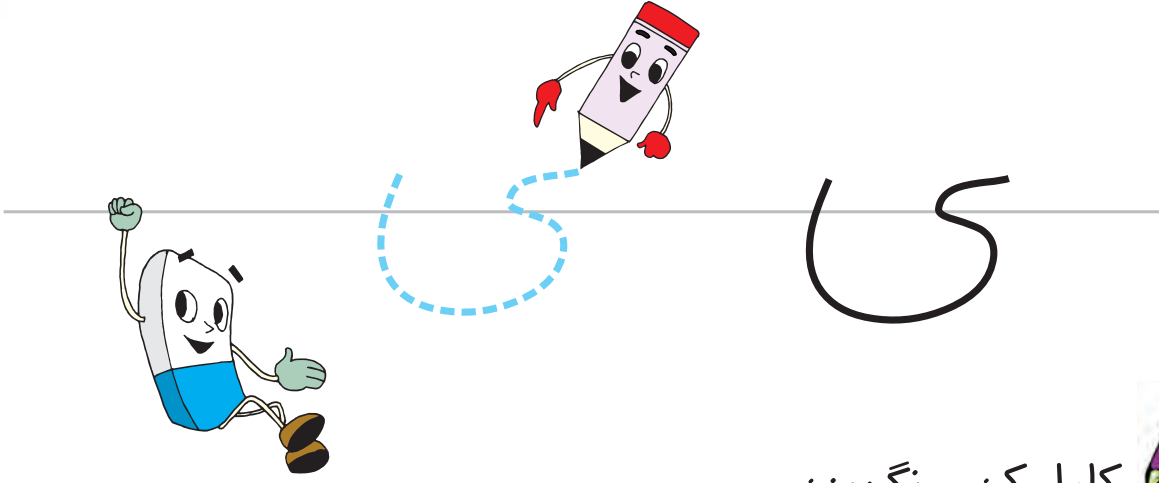

کامل کن و رنگ بزن. 

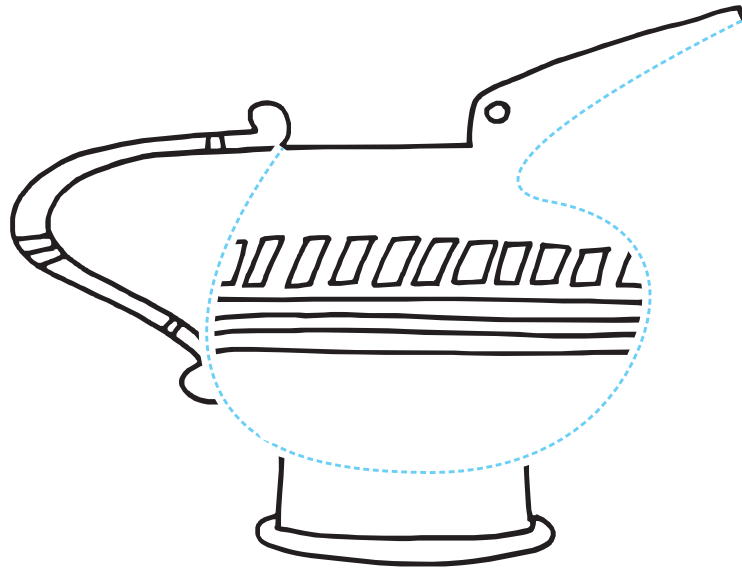

بنویس. 



ی ی ی ی ی ی ی ی ی ی ی



شاد باش!

سلام
فرزندم



بنویس.

س س س س س س س س س س

و و و و و و و و و و

ح ح ح ح ح ح ح ح ح ح





بنویس. 

ط ط ط ط ط ط ط ط ط ط

ث ث ث ث ث ث ث ث ث ث

ذ ذ ذ ذ ذ ذ ذ ذ ذ ذ

